

D862



Short User Manual



English



German



Italian



French



Spanish



Portuguese



Greek



Polish



Russian

Getting started

(1) Unpacking and inspecting the delivery content

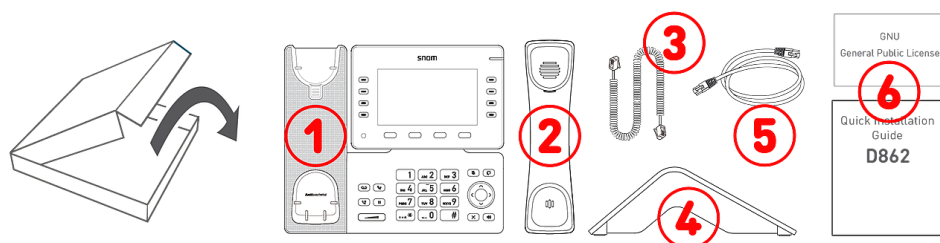

1. IP desk phone D862
2. Handset
3. Handset cord
4. Footstand
5. Ethernet cable: 1.5 m
6. Documentation

(2) Getting to know the D862 components

The hardware components of the D862 can be summarized as follows:

- Audio devices → 1 - 4
- Display and indicators → 5 - 6
- Hard keys → 7 - 12

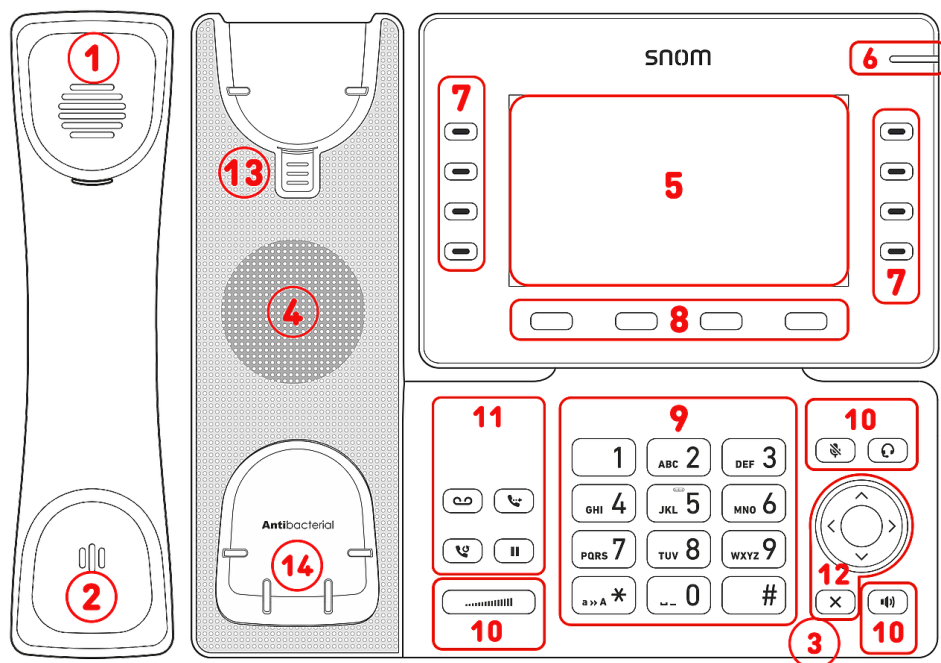

1. Handset earpiece
2. Microphone
3. Casing microphone
4. Casing speaker
5. Display
6. Call status indication
7. 10 SmartLabel keys (with multicolour LED)
8. 4 context-sensitive function keys
9. 12 keys (standard ITU telephone keypad)
- 10.5 dedicated audio keys
- 11.4 dedicated function keys
12. 5-way navigation key & Cancel
13. Handset rest tab
14. Hook switch sensor

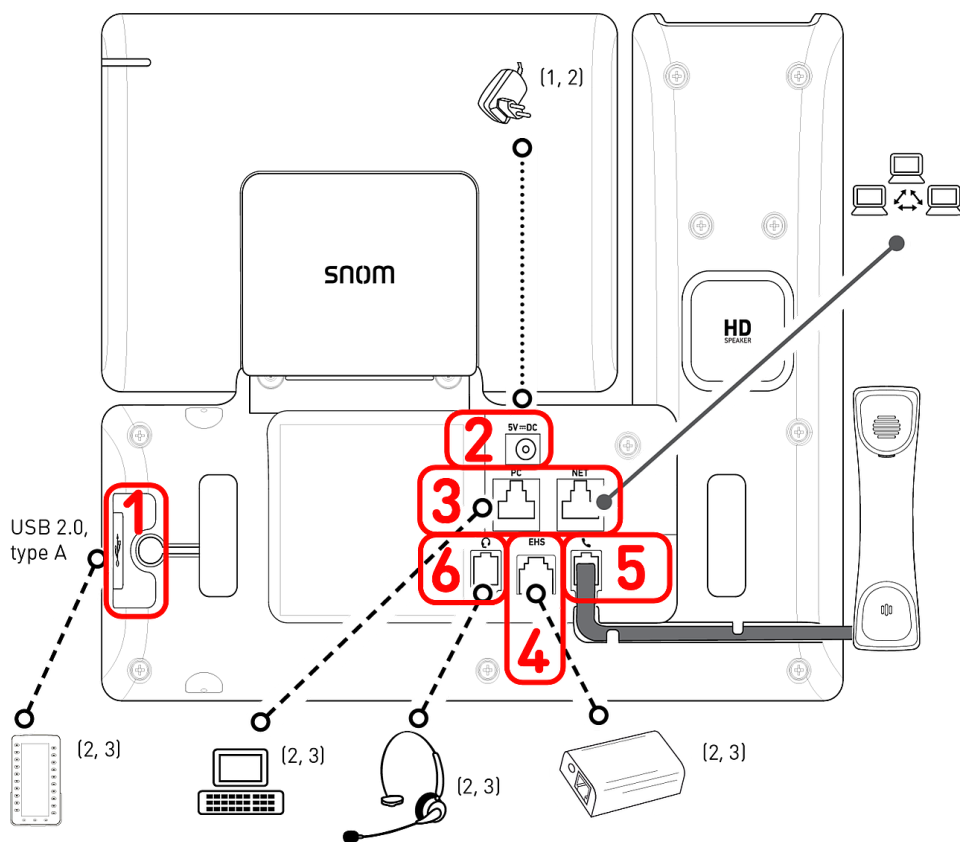
(3) Interfaces and connections**Wired interfaces**

1. USB connectivity | [Expansion module D8C](#):² USB 2.0 type A port
2. Power adapter:¹ coaxial power connector (socket)
3. Network connectivity: 2 × RJ45-8P8C (NET/PC) sockets, Gigabit Ethernet (GbE), [Power over Ethernet \(PoE\)](#), IEEE 802.3af, class 3, IEEE 802.3az⁴
4. [EHS adapter](#):² RJ12-6P6C socket
5. Corded handset: RJ9-4P4C socket
6. Headset:² RJ9-4P4C socket

Wireless interfaces

- -/-

¹ If PoE is not available

² Not included in delivery

³ Optional

⁴ Optional via software

Preparing the D862 for use

(1) Attaching footstand and handset

1. Before attaching the footstand to the phone, plug the long end of the handset cord into the RJ9-4P4C connector labelled  on the back of the phone and place the cord in the cable guide.
2. Place the top of the grooves on the footstand below the slideguides on the back of the D862.
3. Push the footstand upwards onto the slideguides until it locks into place.
4. Plug the short end of the handset cord into the connector on the handset.
5. Place the D862 on an even, horizontal surface.

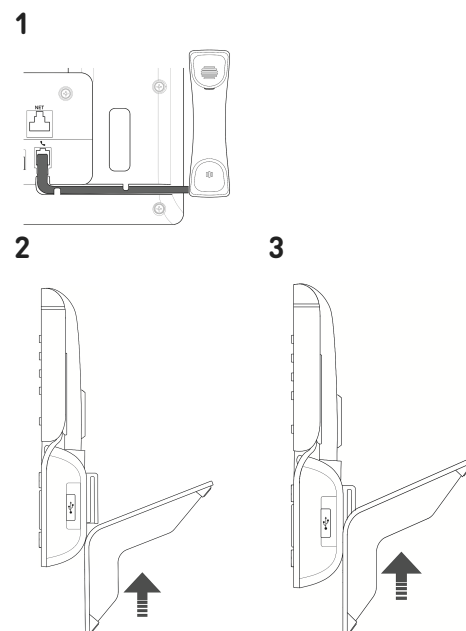

(2) Connecting and powering up

The phone can be operated with Power over Ethernet (PoE) provided via the network cable or, if PoE is not available in your network, with the separately available 5V DC power adapter

1. Plug one end of the Ethernet (network) cable into the RJ45 connector labeled **NET** and the other one into the network side to establish a data link.
2. If PoE is not available, insert the plug of the power supply into the connector labeled **5V DC** and hook up the plug to the wall outlet.
3. The second RJ45 connector, labeled **PC**, is for daisy-chaining further Ethernet devices without the need for a second Ethernet connection line.
4. Snom phones are plug-and-play. Once the phone is connected to your network, it will begin to initialize. If your local network or VoIP provider supports *Snom's auto provisioning features*, the phone will start up automatically without interruption. In this case continue with the next chapter, otherwise refer to chapter [Putting the D862 into operation](#)

Getting to know the display and controls

Display (see → [Getting started](#) → [Getting to know the D862 components](#) → 5)

This display presents the following information:

In idle mode:

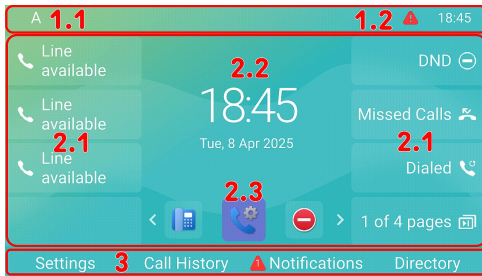

1. Info bar/status line

1. Outgoing SIP identity (see → [Navigation, confirmation, and cancel keys](#))
2. Time | Audio devices | Info (Bluetooth, VPN...)

2. Context area

1. 8 × SmartLabel (see → [SmartLabel keys](#))
2. Date and time
3. 5 × Favicons = shortcuts to menus

3. see → [Context-sensitive, programmable function symbols and function keys](#)

Favicons (see → [Navigation, confirmation, and cancel keys](#))



Preferences



System



Call Features



DND



Voicemail

When the phone is active:

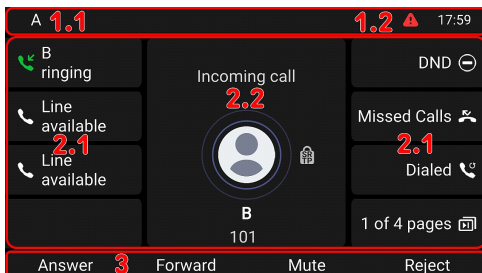

1. Info bar/status line

1. Name of current activity | Outgoing SIP identity
2. Time | Audio devices | Info (Bluetooth, VPN...)

2. Context area

1. 8 × SmartLabel: Depending on the context, the SmartLabels will or not be shown.
2. Depending on the activity, this area will contain symbols (incoming call ringing, outgoing call ringing, list entries, etc.) and text like the phone number calling, the extension number being called, conference partners, etc.

3. Function key line, context-sensitive

Depending on the current activity of the phone, the function key line will present various functions that can be activated by pressing the function key underneath the respective symbol.

Call indicator (see → [Getting started](#) → [Getting to know the D862 components](#) → 6)

The bright-red LED situated on the top right corner of the phone indicates **incoming, ongoing, held, and missed calls**. LED status indications:

- Blinking rapidly when a call is coming in.
- Glowing steadily when dialing, when in a call, and when you have missed a call. To turn the LED off after a missed call, press the right arrow on the navigation key to view the **Missed calls** menu and simultaneously turn off the LED.
- Blinking slowly when you have put a call on hold.

SmartLabel keys (see → [Getting started](#) → [Getting to know the D862 components](#) → 7)

8 SmartLabel keys (freely programmable function keys with LEDs) on the both sides of the display control the SmartLabels. They can be programmed and labeled on the phone via menu-driven phone user interface (PUI) and on the **Function Keys** page of the phone's web user interface (**Phone Manager**).

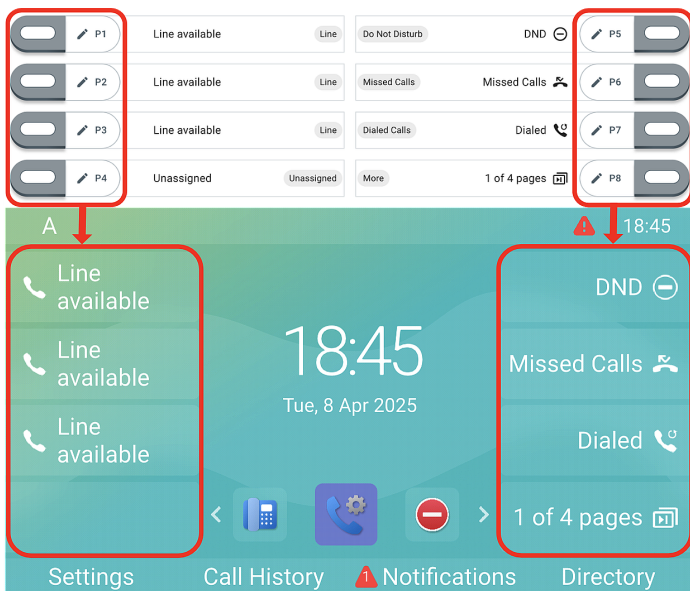

Each of the **8** physical keys can be assigned to different functions on **4 SmartLabel pages**, which finally gives a total number of **32** SmartLabel keys.

Default setting:

- Page 1: **P1-P3** → [Line](#), **P4** → Unassigned, **P5** → Do Not Disturb (DND) mode, **P6** → Missed calls, **P7** → Redial → List diald calls, **P8** → [Next page](#)
- Page 2 (**P9-P15**), 3 (**P17-P23**) and 4 (**P25-P31**) → Unassigned
- Page 2 (**P16**), 3 (**P24**) and 4 (**P32**) → [Next page](#)

You can switch between the SmartLabel pages using the following key:



Next page

Depending on the function mapped onto the key, the red or green LEDs on the key will be activated when the key event occurs. The LED of a **line** key will

- blink rapidly when a call is ringing on the line
- glow steadily when there is an ongoing call on the line
- blink slowly when a call is on hold on the line
- be off when the line is free.

Depending on the key type, label areas are composed of icon and text, or only text respectively. Both can also be customised. The following **key types** are available with current firmware:

- Unassigned
- Line
- Do Not Disturb
- Call Forward Always
- Call History
- Speed Dial
- Directory
- Menu
- Busy Line Field
- Private Hold
- Dialed Calls
- Voicemail
- Transfer
- More
- Conference
- Extension
- Call Parking
- Hold
- Status
- Missed Calls
- Received Calls
- Redial
- XML Definition
- Server Directory
- ACD (Automatic Call Distribution)
- Action URL
- Multicast
- Multicast Zones
- Voicemail Info
- Identities
- Intercom

Key types: Unassigned

Line	Do Not Disturb	Forward all	Call history	Speed Dial
Directory	Settings	Busy Lamp Field	Private Hold	Dialed calls
Voicemail	Transfer	Next page	Conference	Extension
Call Parking	Hold	Status	Missed Calls	Received calls
Redial	Server Directory	XML Definition	Automatic Call Distribution	Action URL
Multicast	Multicast Zones	Voicemail Info	SIP identities	Intercom

Context-sensitive, programmable function symbols and function keys (see → [Getting started](#) → [Getting to know the D862 components](#) → 8)

4 context-sensitive, programmable function keys (F1 - F4) are located directly below the display and can be programmed on the **Function Keys** page of the phone's web interface (**Phone Manager**) with a number of key events; these functions will then be available when the phone is in idle mode. Default settings depend on the firmware installed on the phone.

Standard functions available on idle screen:

- **F1:** Settings → Settings menu
- **F2:** Call History → Call lists (missed, received, dialled calls)
- **F3:** Notifications or Info → Status information
- **F4:** Directory → Accessing the built-in directory of the phone

Press the function key underneath the display symbol to activate the function, open the list etc. depicted by the symbol above the key.

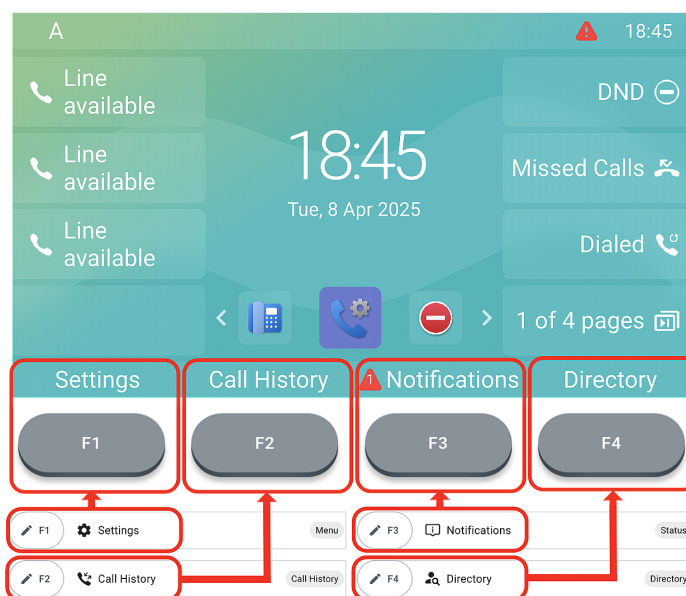

Alphanumeric keypad (see → [Getting started](#) → [Getting to know the D862 components](#) → 9)

1 alphanumeric keypad consisting of 12 hard keys, located in the center of the lower device part.



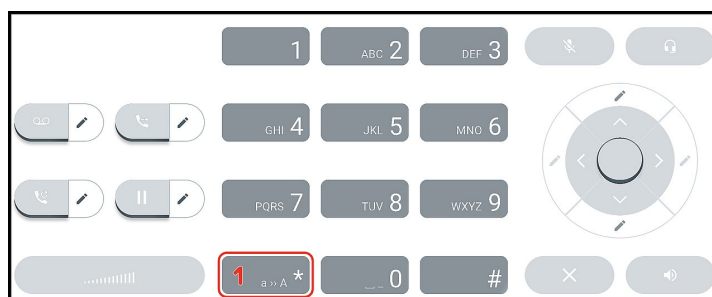

- **In editing mode:** Press **(1)** for one second to change input mode (numerals > lower case > upper case) or press **(1)** briefly to type *.
- **On idle screen:** Press **(1)** for 3 seconds to lock/unlock the keypad.

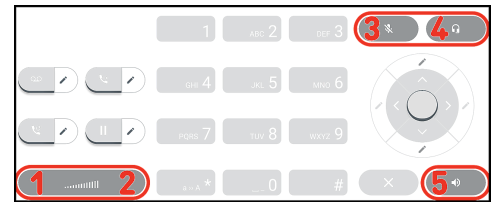

Audio control keys (see → [Getting started](#) → [Getting to know the D862 components](#) → 10)

5 audio control keys are used to adjust the volume, for muting and unmuting the microphone, to activate speakerphone and headset mode.





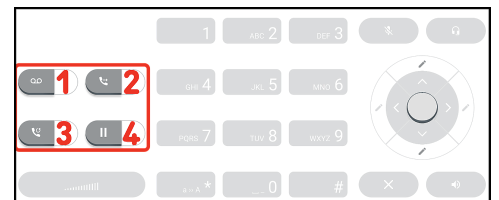

- | | | | |
|--|---|--|--|
| <p>1 </p> <p>Volume + / -</p> <ul style="list-style-type: none"> Adjusting the volume of the ringer when the phone is idle or ringing Adjusting the volume of the loudspeaker in handset, casing, or headset, respectively, when in call | <p>2 3 </p> <p>Mute</p> <ul style="list-style-type: none"> Muting and unmuting the microphone Has a red LED that lights up when and as long as the microphone is muted. | <p>4 </p> <p>Speakerphone</p> <ul style="list-style-type: none"> Toggling between handsfree and handset mode Dialling and accepting calls on speakerphone Has a green LED that lights up when and as long as the mode is activated | <p>5 </p> <p>Headset</p> <ul style="list-style-type: none"> Toggling headset mode on and off |
|--|---|--|--|

Dedicated, customizable function keys (see → [Getting started](#) → [Getting to know the D862 components](#) → 11)

4 preprogrammed, variably programmable function keys have their factory settings printed on the key. Other functionalities can also be programmed onto them.



- | | | | |
|--|---|--|--|
| <p>1 </p> <p>Message</p> <ul style="list-style-type: none"> Retrieving messages from the mailbox (if applicable) Has a red LED that lights up when there is a new message on the mailbox | <p>2 </p> <p>Transfer</p> <ul style="list-style-type: none"> see → Using the phone → (5) Transferring calls | <p>3 </p> <p>Redial</p> <ul style="list-style-type: none"> Redial (via dialed calls list) | <p>4 </p> <p>Hold</p> <ul style="list-style-type: none"> Holding or unholding an active call |
|--|---|--|--|





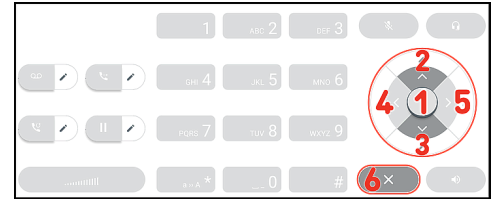



Navigation, confirmation, and cancel keys (see → [Getting started](#) → [Getting to know the D862 components](#) → 12)

They can be programmed with the key events available in their drop-down menus.

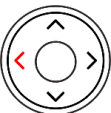
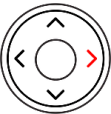

You can select a different key event to be available on each respective key when the phone is in idle mode. You cannot change the functions that are available when the phone is active, for example when you are in a call, when the phone is ringing, etc.

Default setting:

- | | | |
|--------|--|--|
| 1 |  <p>Confirm</p> | <ul style="list-style-type: none"> • On idle screen: call features menu • Accepting calls on speakerphone and in headset mode • Confirming, saving actions & input, and returning to previous screen |
| 2
3 |  <p>Navigation key: up/down</p> | <ul style="list-style-type: none"> • On idle screen: Select the outgoing identity <div style="background-color: #00a651; color: white; padding: 2px; display: flex; align-items: center; justify-content: space-between;"> ⏮ A 🚨 19:30 </div> <ul style="list-style-type: none"> • In other contexts: Navigate up/down |
| 4 |  <p>Navigation key: left</p> | <ul style="list-style-type: none"> • On idle screen: Select a favicon = shortcuts to menus |
| 5 |  <p>Navigation key: right</p> | <div style="display: flex; justify-content: space-around; align-items: center; margin-bottom: 10px;"> <div style="text-align: center;"> 
 Preferences </div> <div style="text-align: center;"> 
 System </div> <div style="text-align: center;"> 
 Call Features </div> <div style="text-align: center;"> 
 DND </div> <div style="text-align: center;"> 
 Voicemail </div> </div> <ul style="list-style-type: none"> • In editing mode: Moving the cursor to the left one character at a time or Moving the cursor to the right one character at a time |
| 6 |  <p>Cancel</p> | <ul style="list-style-type: none"> • Terminating calls on speakerphone and in headset & handset modes • Canceling actions & input, and returning to previous screen |

Putting the D862 into operation

(1) Initializing and registering the phone

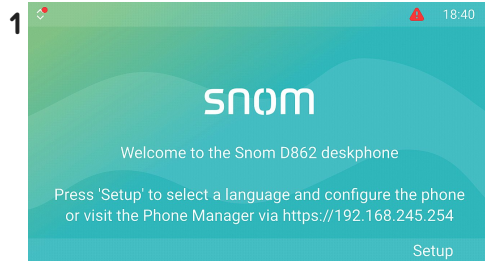

When the phone has been connected, it will show the welcome screen with the IP address of the **Phone Manager**. It is more convenient and therefore recommended to perform the first time setup using the **Phone Manager**. Enter the *IP address* into the browser's address bar on a computer in the same network as the phone.

2 The page **Snom Phone Manager** opens.

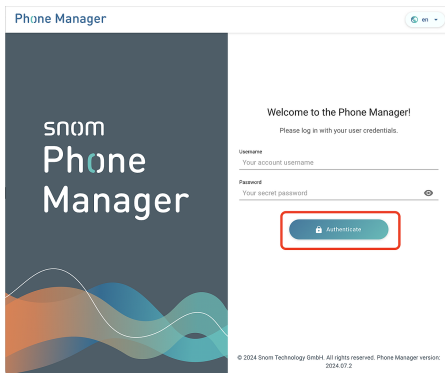

Click on **Authenticate (button label)**. The page **Welcome to the Phone Manager** opens (**page title**)

5 The page **Time & Date** opens (**dialog title**).

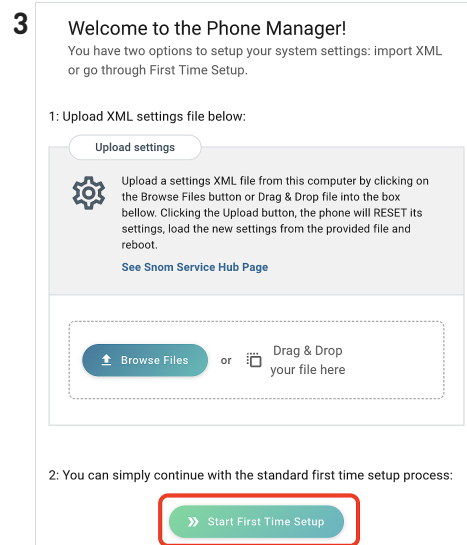
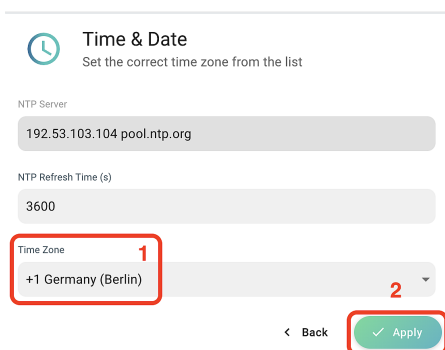

Click on **Start First Time Setup (button label)**.

1. Next, you will be prompted in the language of your choice to select a **time zone**. This affects the time shown on your display.
2. When done, click **Apply**.

The page **Account Credentials** opens (**dialog title**).

4 The page **Language** opens (**page title**).

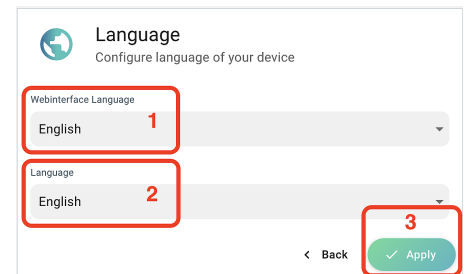

You will be prompted to select a **language**

1. **Web user interface (WUI)**
2. **Phone user interface**
3. When done, click **Apply**.

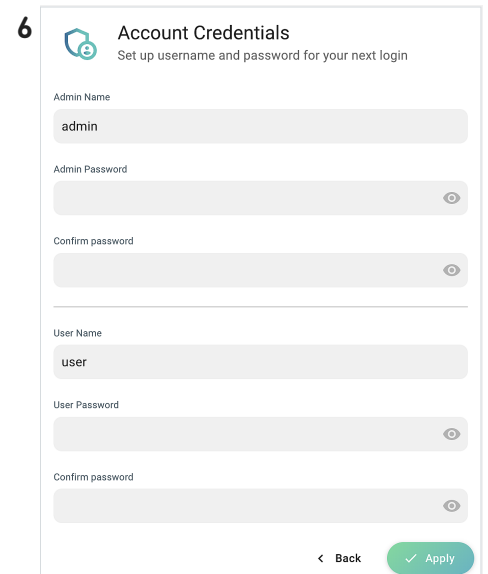

7 Enter an **admin username and password** for accessing the phone's web user interface (Phone Manager).

1. The suggested user name can be used or a new one can be entered.
2. You are obliged to set a proper **admin password** to operate the phone.
3. Re-enter the password for confirmation.
4. When done, click **Apply**.

8 The phone is now ready to set up the first SIP identity (account) to be fully operational. **On idle screen:**

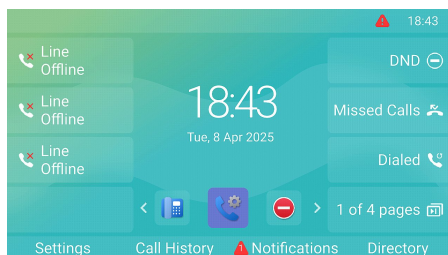

The page **Your device is ready** opens (dialog title).

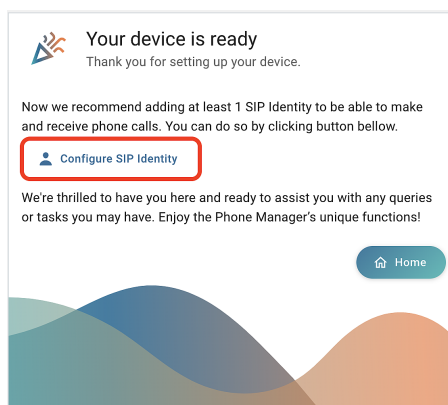

Click on **Configure SIP Identity** (button label).

9 The page **Home - Identities - 1 - Profile** opens (page title → page titles).

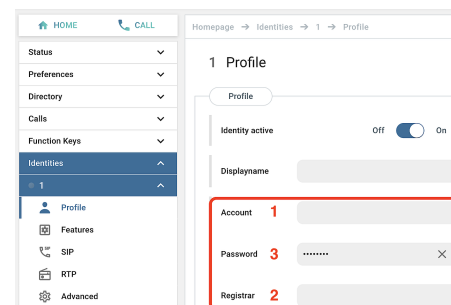

Enter the (1) **Account**, the (2) **Password**, and the (3) **Registrar** received from your Internet service provider or administrator. When done, click **Apply**.

After successful registration you will see the **idle screen** with the registered identity in the upper left corner.

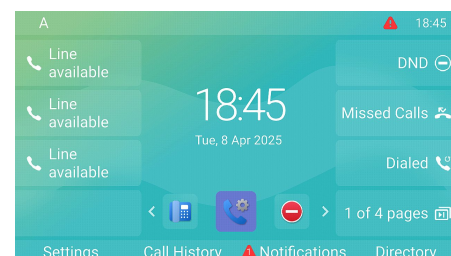

(2) Adjusting the D862 settings

A comparatively small number of settings can be adjusted directly **on the phone** via *menu-driven phone user interface (PUI)*; many more can be conveniently customized via the *phone's web user interface (Phone Manager)* from a **computer with web browser**.

Note: Snom phones can be operated in administrator or user mode. In administrator mode, all settings are accessible and can be modified; in user mode, a number of settings are not accessible. → **Default setting:** administrator mode

Phone user interface

On idle screen:

Press

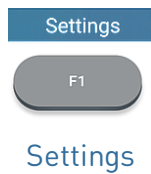

to open the settings menu on the display. To open submenus and settings, select the submenu or setting with the navigation key and press



Web user interface (WUI) / Phone Manager

1. Press the function key underneath **Settings** on the phone's display and select **Help** to look up the phone's IP address.

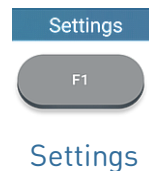

2. Enter the *IP address* into the browser's address bar on a computer in the same network as the phone. The page **Welcome to the Phone Manager** opens (**page title**).

3. Log into the Phone Manager using the correct credentials. The page **Home** opens (**page title**).

Available items in the vertical menu on the left side of the window depend on whether the phone is running in user or administrator mode. Any changes you make on the web interface will not take effect until you click on **Save** or on **Apply** and **Save**, depending on your firmware version. Changes will be lost if you open another page of the web interface without first clicking on **Apply/Save**.

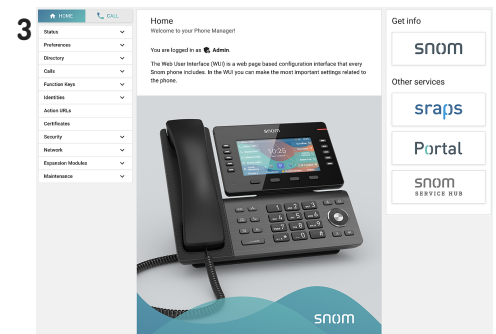
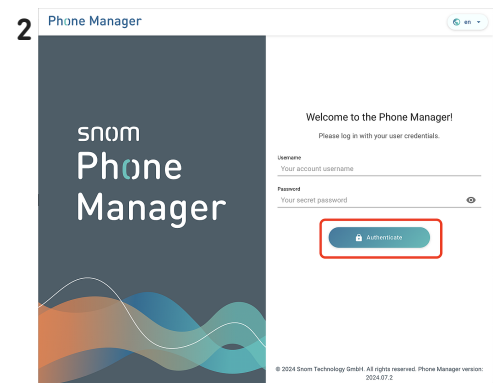
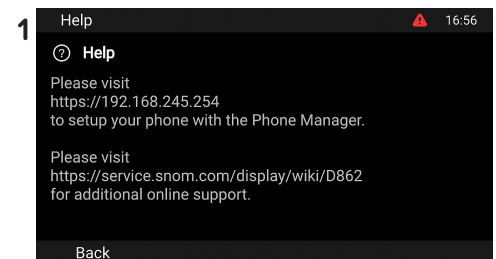

Using the phone

This section describes the functions of the phone with the factory default settings. If your phone was installed and/or set up by someone else, the default settings may have been changed. Please check with that person or company if the phone does not react as described here.

The caller information displayed on the screen is controlled by a setting on the phone's web interface. The default setting is *Name + Number*.

(1) Making calls

1. **Selecting identity** for current outgoing call



2. Using different **audio devices**

- Handset: Pick up the handset, enter the phone number, and confirm with



Confirm

or



Dial

or enter the phone number and pick up the handset.

- Headset: Enter the phone number and press



Headset

- Speakerphone: Enter the phone number and press



Speakerphone

or



Dial

(2) Accepting calls

Using different **audio devices**

- Handset: Pick up the handset.
- Headset: Press  If the phone is already in headset mode, you can also press the blinking line key.



Headset

- Speakerphone: Press



Speakerphone

or

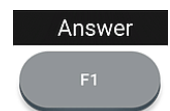

Answer

(3) Terminating calls

- When using the handset: place the handset in the cradle or
- When using speakerphone or a headset: Press



Cancel

or

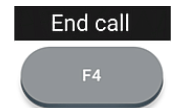

End call

(4) Active calls

One call on hold

Press



Hold

or



Hold

to put the ongoing call on hold. Held calls are indicated as follows:

- By the text on the display.
- By the slowly blinking line key.
- By the slowly blinking call indication LED.
- By the double beep when you put a call on hold.

You can now:

- transfer the held call blindly or with prior announcement.
- receive and make calls and put other calls on hold.

Pick up the held call by pressing its line key or press again



Hold

or

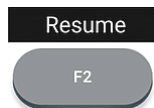

Resume

If the other party hangs up while on hold, the call is terminated on your phone as well and the LED indicators are turned off.

Holding multiple calls

Display → Context area:

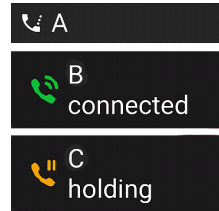

Two calls, one active, one on hold.

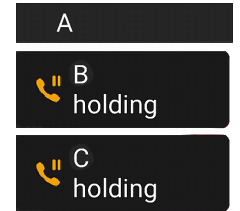

Two calls, both on hold.

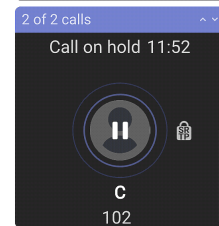
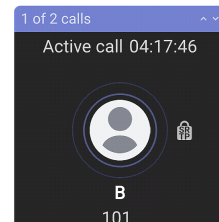

Press

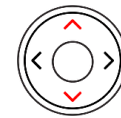

Navigation key:
up/down

to scroll through the calls.

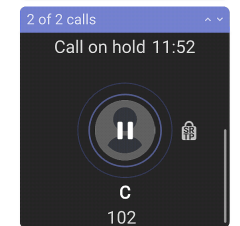
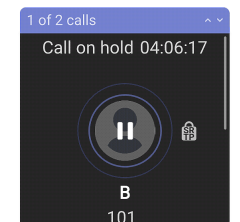

You can now:

- switch back and forth between the active call and any call on hold. Up to 12 simultaneous calls are possible, if supported by the VoIP telephony system.
- Your input on the phone's keys will affect the call on the display. It can be resumed, terminated, or selected for conference setup.
- When a held call is on-screen, press



Hold

or

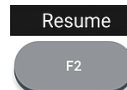

Resume

to connect to it and put the currently connected call on hold.

(5) Conference

The maximum number of participants in phone-based conferences is **5** (you and 4 others). For the number of participants in server-based conferences and how to set up and join them, please check with your network administrator or your VoIP provider.

1. **Initiating a conference:** With a call **(B, 101)** on the line, press

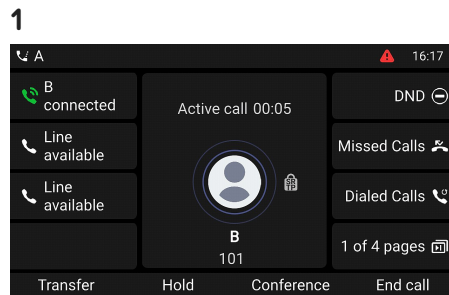

2. The call **(B, 101)** is put on hold. The page **Conf setup** opens (**page title**). Enter the number or select a call from the phone's call list. Call the next intended participant **(C, 102)** and announce the conference.

3. Press

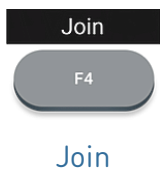

to start the 3-way conference

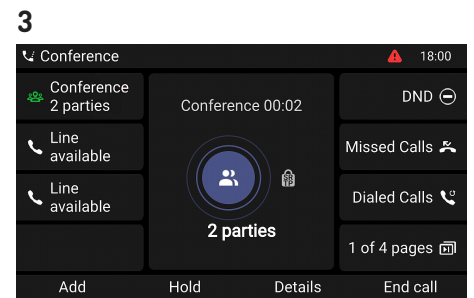
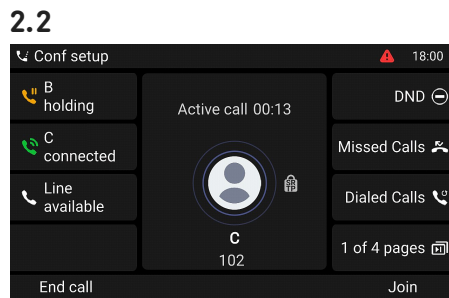

You can now:

- Put the conference on hold.

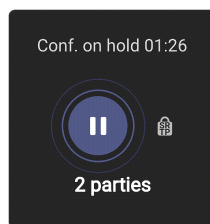
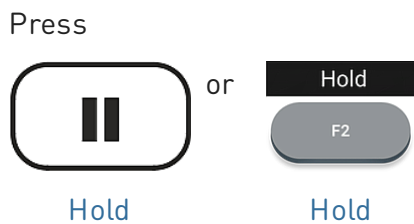

- Press

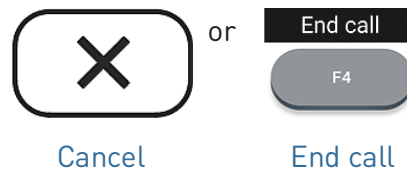

to terminate the conference.

- Press

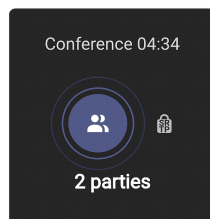
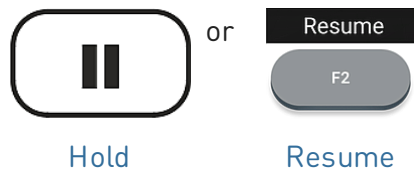

to restart the conference.

- Press

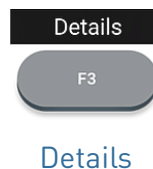

The page **Details** opens

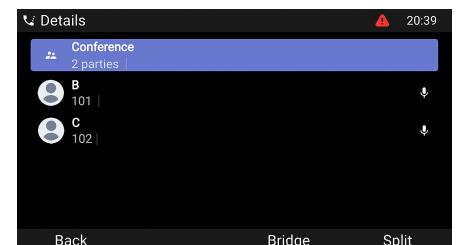

Use the navigation key to select individual participants or the conference. Your input on the phone's keys will affect the highlighted participant or the entire conference.

- You can end or split the highlighted conference.
- You can mute or remove the highlighted individual participant.

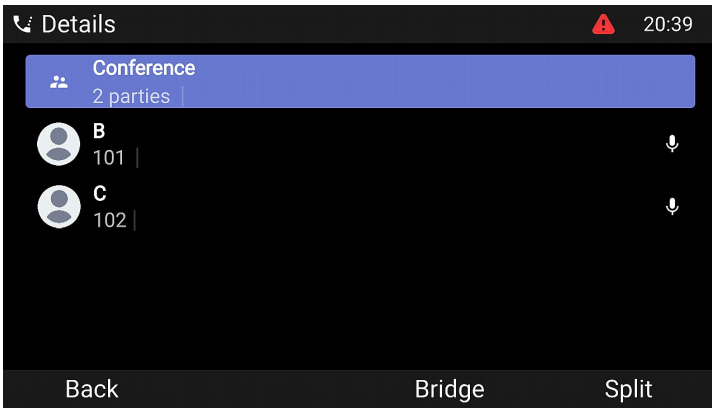

Press



Bridge

Press



Split

to terminate the conference. You leave the conference, the two external participants (**B, 101**) and (**C, 102**) continue talking.

to terminate the conference. → Two calls, both on hold.

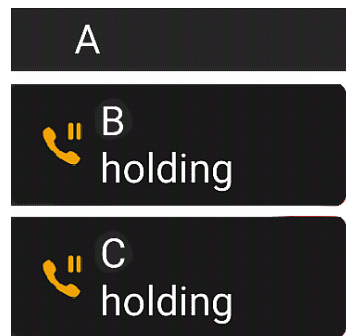

Press



Mute

or



Unmute

to mute/unmute the selected call (**C, 102**) during the conference.

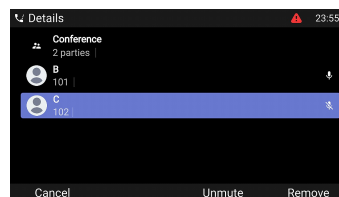

Press



Remove

to remove the selected call (**C, 102**) from the conference. This will also terminate the conference. → 1 active call (B, 101)

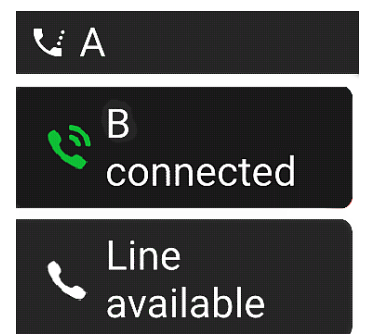

(5) Transferring calls

You can transfer connected calls as well as deflect calls ringing on your phone.

- When you have a call on the line, there are two ways to transfer it to a third party
 1. **Attended call transfer:** Announcing the call to the third party first, to make sure the call is welcome and will be accepted.
 2. **Blind call transfer:** There will be no feedback on whether the third party is available and/or picking up the call.
- When a call is ringing on your phone, you can redirect it to a third party without answering it first. → [Call deflection](#)

Attended call transfer: with a single call on the phone

1. With an active call (**B, 201**) on the line, press

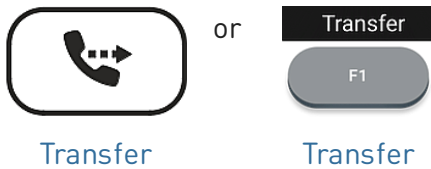

1.1

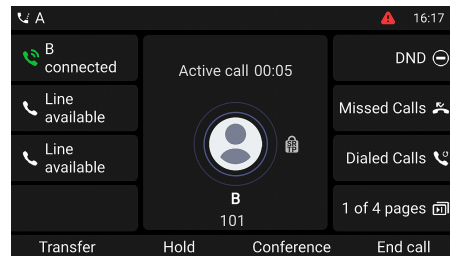

1.2

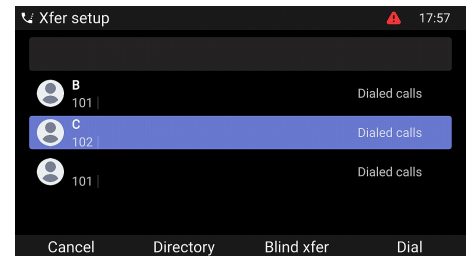

The call (**B, 201**) is put on hold. The page **Xfer setup** opens (**page title**).

2. Enter the number or select a call from the phone's call list. Press

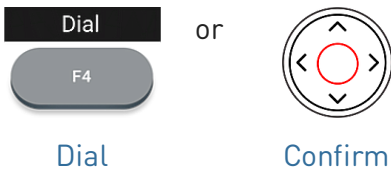

Dial the number (**C, 102**) you want to transfer the call (**B, 101**) to and announce the call.

Note: If the third party does not want to take the call, press **End call**

2

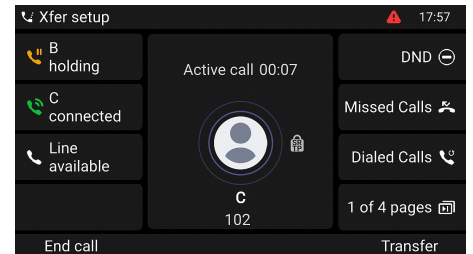

3. If the third party (**C, 102**) wants to accept the call, press



to complete the transfer.
→ You may briefly see screen message *Call ended B 101* indicating that the transfer was completed. **B (101)** is in a call with **C (102)** now.

3

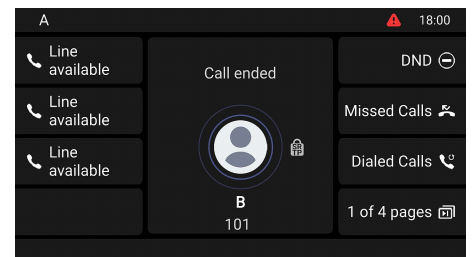

Attended call transfer: with more than one call → **B, 101 + D, 103**

1. The active call (**B, 101**) will be transferred. If the active call (**B, 101**) is not the one you want to transfer, put it on hold and select the other call (**D, 103**).

1.1

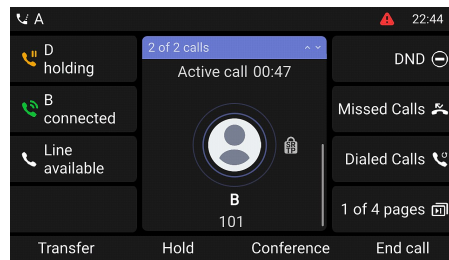

1.2

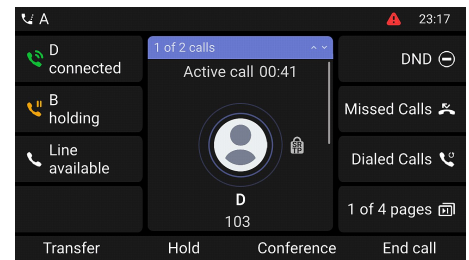

2. Press

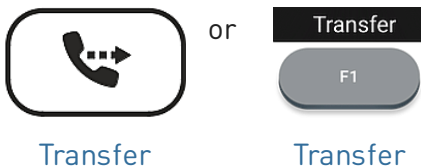

→ The call (**B, 201**) is put on hold. The page **Xfer setup** opens (**page title**).

2

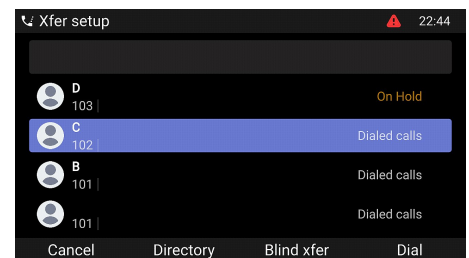

3. Enter the number or select a call from the phone's call list. Press



Dial the number (**C, 102**) and announce the conference.

Note: If the third party does not want to take the call, press **End call** (**F4**)

3

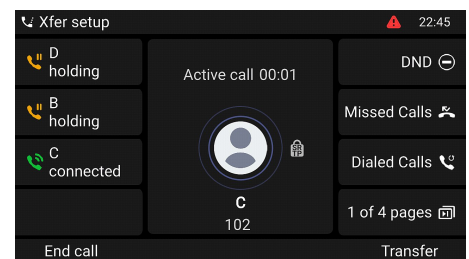

4. If the third party (**C, 102**) wants to accept the call, press

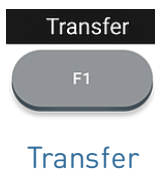

to complete the transfer.

→ **B (101)** is in a call with **C (102)** now.

→ The remaining call on hold or the first of the remaining calls on hold will then appear on-screen (**D, 103**).

4

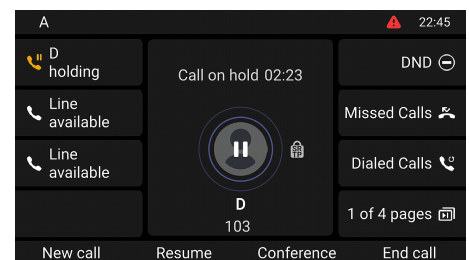

Blind call transfer: active call (**B, 101**)

1. With an active call (**B, 101**) on the line, press

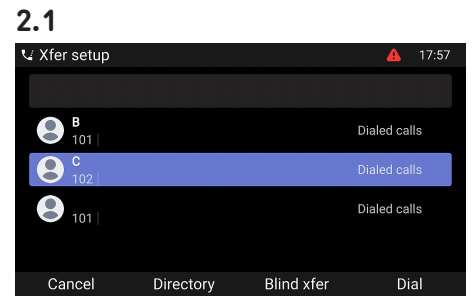
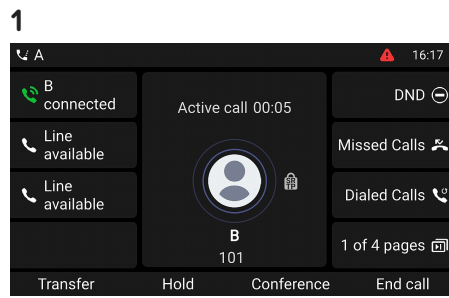
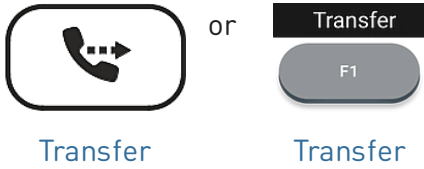

→ The call (**B, 101**) is put on hold. The page **Xfer setup** opens (**page title**).

2. Enter the number manually or select a number from the phone's call lists. Press



Blind call transfer

to complete the deflection.
 → The display shows the message *Call ended B 101* while the call is ringing on the third party's phone.
 → **B (101)** is ringing **C (102)** now.

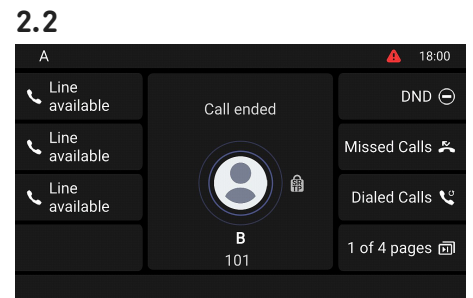

Call deflection (call waiting **C 102**)

1. If you are in an active call (**B, 101**) and want to deflect an incoming call waiting (**C, 102**), press

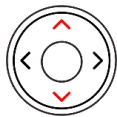

Navigation key: up/down

→ The incoming call waiting appears on-screen.
 → Your active call remains active while you are transferring the ringing call.

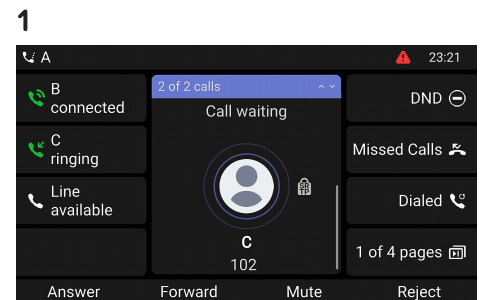

2. Press

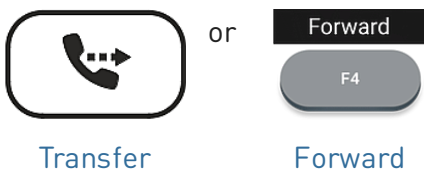

→ The page **Forward call** opens (**page title**).

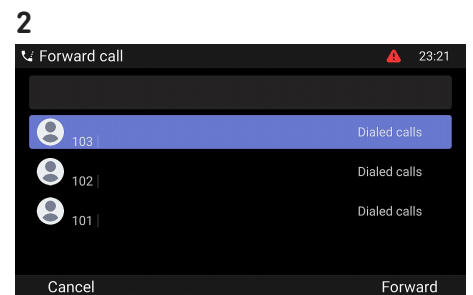

3. Enter the number manually or select a number from the phone's call lists.



to complete the deflection.
 → **C (102)** is ringing **D (103)** now.
 → Your active call (**B, 101**) reappears on-screen.

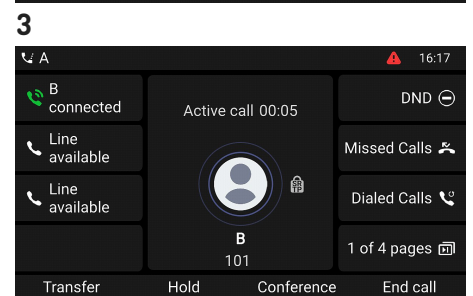

Call deflection (ringing call **B 101**)

1. With an incoming call ringing (**B, 101**), press

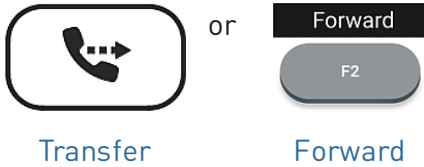

→ The page **Forward call** opens (page title).

2. Enter the number manually or select a number from the phone's call lists. Press



to complete the deflection.
→ **B (101)** is ringing **C (102)** now.

1

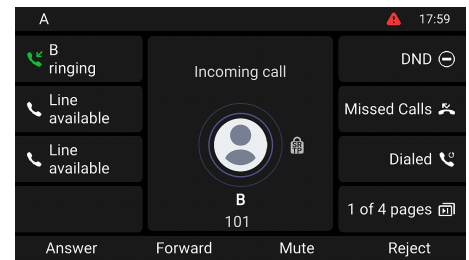

2

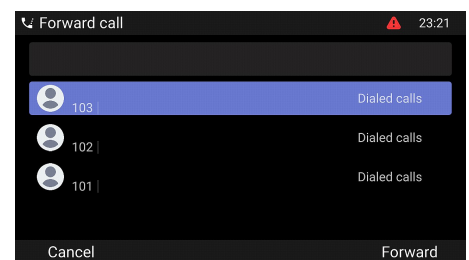

(6) Call lists

Four call lists of missed, diald, received, and all calls are stored on the phone.

1. **On idle screen:** press the function key underneath the following symbol

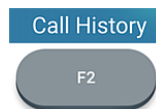

Call history

2. To display the lists of missed, received, or diald calls on-screen, use the navigation key (left/right). On each list, the latest call is at the top of the list. Scroll through the list using the navigation key (up/down). The icons indicate the type of call.



Navigation key

1

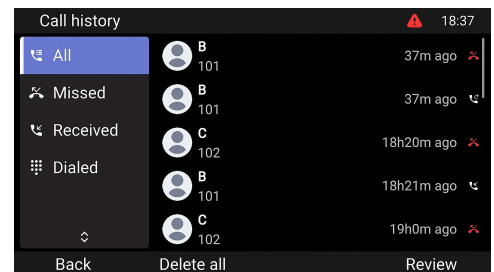

Software update

Manual update

1. Go to Snom's Firmware Update Center and find the latest firmware version for your D862.
2. Please read the instructions and release notes before downloading the firmware.
3. **Right-click** the *download link* in the Firmware files table and **copy the link**.
4. Open the phone's web user interface (**Phone Manager**). Navigate to page *Software Update (...)*. In the *Manual Software Update* area, paste the link into the text field of **Firmware**.
5. Click **Load**. The phone begins to reboot.
6. **Note: DO NOT DISCONNECT THE POWER WHILE THE D862 IS REBOOTING!**

Auto provisioning

1. Open the **Phone Manager** and click **Maintenance**.
2. Click **Provisioning**.
3. Click the individual settings for their details.
4. When done, click **Apply**. If you have the changed the setting URL and/or the *PnP configuration*, a reboot is required before they will take effect.

For more information, see our [web page](#).

3

Downloads

Firmware Files

Phone Model	File Size	SHA-256 Checksum	Download Link
D862	133.8 MB	482537d972977fc53e46b1f95481f2386cabf951336a42647f8663b4697f6a823dc	https://downloads.snom.com/fw/10.1.10.1/bin/snomD862-10.1.10.1-HW6-SIP-r.swu

4

Software Update

Phone Status

Phone Type: snomD862
 MAC Address: 00047120201181
 Firmware version: snomD862-SIP-R-10.1.10.1-202407080000
 U-Boot version: 2017.07-ud-10-a0 (Date: 18.03.2018 18:45:00)

Manual Software Update

You may explicitly specify which software version you want to run on this phone. Fill in the URL which is pointing to the firmware you want to use. Please use only a complete URL (like <http://www.example.com/firmware.swu>). Once the update has finished, the phone will reboot.
 See Snom Service Hub Page

Firmware URL

Phone Controls

You can reset a phone to factory defaults. The Snom Phone will reset all settings and reboot.
 See Snom Service Hub Page

© 2024 Snom Technology GmbH. All rights reserved. Phone Manager version: 2024.07.0

Provisioning

Trigger resynchronization of the settings with the setting server.
 See Snom Service Hub Page

Prov Polling

Polling Mode: Relative

Polling Period: 0

Polling Time: 00:00

Polling Time Random End: 00:00

Setting URL: <https://secure-provisioning.snom.com>

Update Policy: Never update, load settings only

Settings Refresh Timer: 0

Provisioning Order: redirection:stop pnp:stop dhcp:stop t859:stop

Uboot lock: X

Prov Polling

If set to on, the phone will periodically fetch the provisioning files (configuration and/or software updates). See (Provisioning polling) for more information on how to use this setting.
 See Snom Service Hub Page

Troubleshooting

Contacting Snom Support

Click this text (or scan the QR code) to read and follow the detailed instructions given on our website.



Submitting a ticket

Click this text (or scan the QR code) to read and follow the detailed instructions given on our website.



Submitting system and settings information

- [System information](#)
- [Settings information](#)

SIP traces

Snom Support may ask you to submit a SIP Trace and/or a PCAP Trace to help them analyze your problem.

- [Performing a SIP trace](#)
- [Performing a PCAP trace](#)

Important information

This **D862 Short User Manual** has been derived from the more extensive user manual to give users a more concise overview in their own language. Please refer to the **D862 user manual** regarding the following topics:

- [Copyright, Trademarks, GPL, Legal Disclaimers](#)
- [Safety instructions](#)
- [Standards conformance](#)
- [Product specifications](#)
- [Disposal of the device](#)
- [Cleaning](#)

Disclaimer

Further information: [Snom D862 webpage](#) | [Snom Service Hub](#) | [Quick Installation Guide](#) | [Data sheet](#) | [User manual](#) | [Warranty information](#) | [Type approval](#) | [Company locations](#)

Snom, the names of Snom products, and Snom logos are trademarks owned by Snom Technology GmbH. All product specifications are subject to change without notification. Snom Technology GmbH reserves the right to revise and change this document at any time, without being obliged to announce such revisions or changes beforehand or after the fact. Although due care has been taken in the compilation and presentation of the information in this document, the data upon which it is based may have changed in the meantime. Snom therefore disclaims all warranties and liability for the accurateness, completeness, and currentness of the information published, except in the case of intention or gross negligence on the part of Snom or where liability arises due to binding legal provisions.