

D785 / D785N / D787



Short User Manual

Getting started

(1) Unpacking and inspecting the delivery content

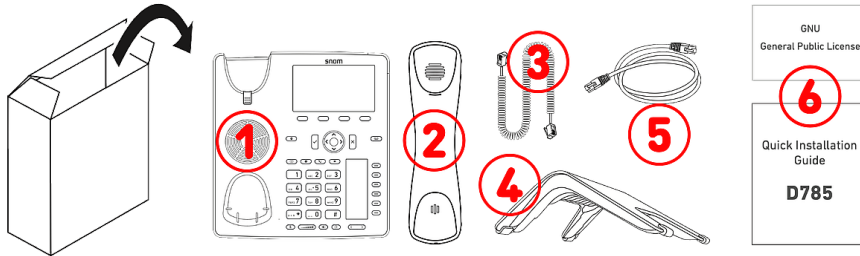

1. IP desk phone D785 / D785N / D787
2. Handset
3. Handset cord
4. Footstand
5. Ethernet cable: 1.5 m
6. Documentation

(2) Getting to know the D785 / D785N / D787 components

The hardware components of the D785 / D785N / D787 can be summarized as follows:

- Audio devices → 1 - 4
- Display and indicators → 5 - 6
- Hard keys → 7 - 12

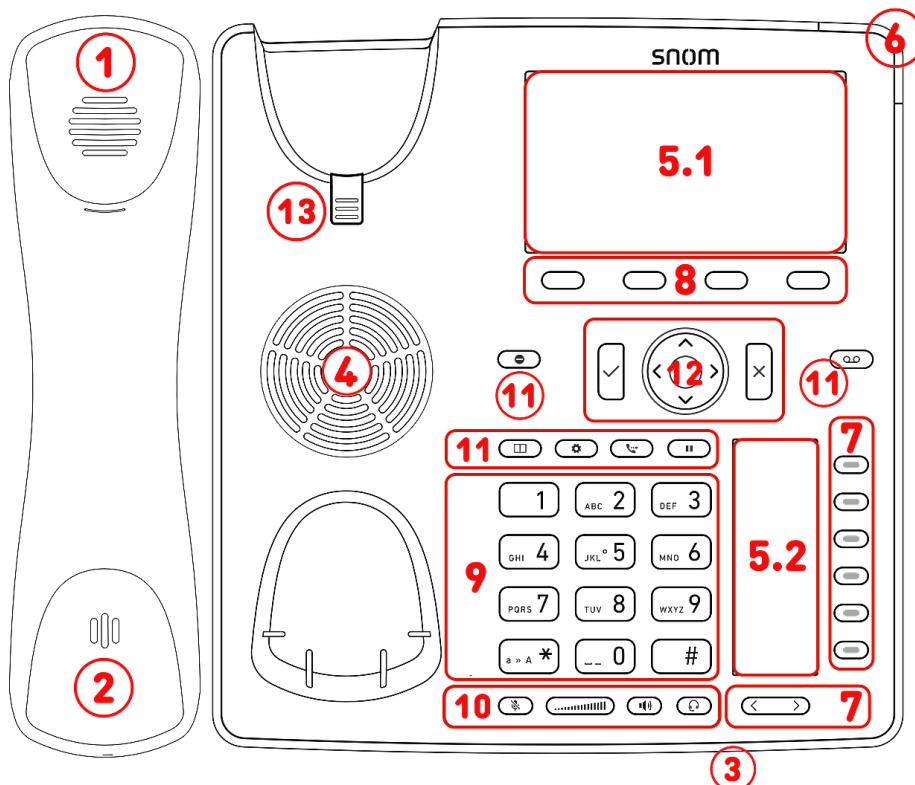

1. Handset earpiece
2. Microphone
3. Casing microphone
4. Casing speaker
5. 1. Display
2. SmartDisplay
6. Call status indication (with red LED)
7. 6 SmartLabel keys (with multicolour LED) & Page
8. 4 context-sensitive function keys
9. 12 keys (standard ITU telephone keypad)
- 10.5 dedicated audio keys
- 11.6 dedicated function keys
- 12.5-way navigation key & Ok / Cancel
13. Handset rest tab

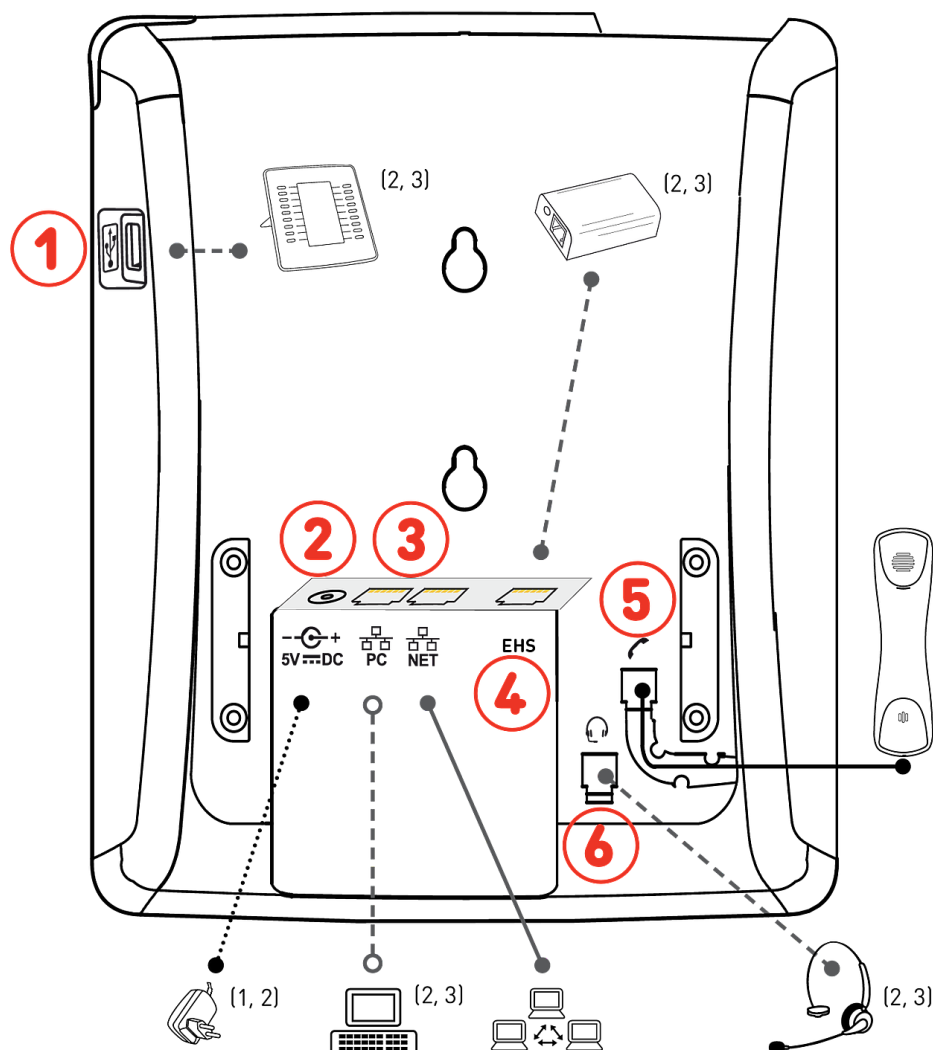
(3) Interfaces and connections**Wired interfaces**

1. USB headsets and other accessories: USB 2.0 type A port
2. Power adapter: coaxial power connector (socket)
3. Network connectivity: 2 × RJ45-8P8C (NET/PC) sockets, Gigabit Ethernet (GbE), **Power over Ethernet (PoE)**, IEEE 802.3af, class 2/3⁵, (D787: IEEE 802.3az)⁶
4. EHS adapter: RJ12-6P6C socket
5. Corded handset: RJ9-4P4C socket
6. Headset: RJ9-4P4C socket

Wireless interfaces

- D785 → **Headset connectivity:** Bluetooth 4.0, class 2⁴
- D787 → **Network connectivity:** Wireless LAN

¹ If PoE is not available

² Not included in delivery

³ Optional

⁴ D785N / D787 without Bluetooth

⁵ Class 2 w/o USB and Bluetooth

⁶ Optional via software

Preparing the D785 / D785N / D787 for use

(1) Attaching footstand and handset

Note: The footstand can be attached at two different angles: low angle **28°** or high angle **46°**

1. Before attaching the footstand to the phone, plug the long end of the handset cord into the RJ9-4P4C connector labelled  on the back of the phone and place the cord in the cable guide.
2. Place the top of the grooves on the footstand below the slideguides on the back of the D785 / D785N / D787.
3. Push the footstand upwards onto the slideguides until it locks into place.
4. Plug the short end of the handset cord into the connector on the handset.
5. Place the D785 / D785N / D787 on an even, horizontal surface.

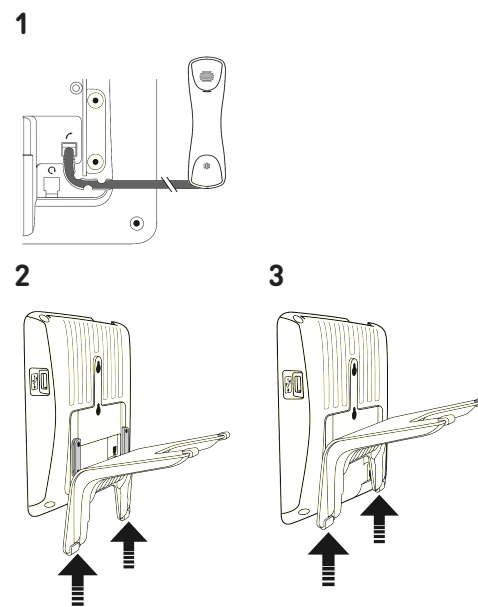

(2) Connecting and powering up the phone

The phone can be operated with Power over Ethernet (PoE) provided via the network cable or, if PoE is not available in your network, with the separately available 5V DC power adapter

1. Plug one end of the Ethernet (network) cable into the RJ45 connector labeled **NET** and the other one into the network side to establish a data link.
2. If PoE is not available, insert the plug of the power supply into the connector labeled **5V DC** and hook up the plug to the wall outlet.
3. The second RJ45 connector, labeled **PC**, is for daisy-chaining further Ethernet devices without the need for a second Ethernet connection line.
4. Snom phones are plug-and-play. Once the phone is connected to your network, it will begin to initialize. If your local network or VoIP provider supports *Snom's auto provisioning features*, the phone will start up automatically without interruption. In this case continue with the next chapter, otherwise refer to chapter ***Putting the D785 / D785N / D787 into operation***

Getting to know the display and controls

Display (see → *Getting started* → *Getting to know the D785 / D785N / D787 components* → 5.1)

This display presents the following information:

In idle mode:

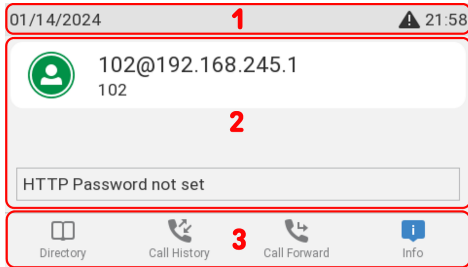

When the phone is active:

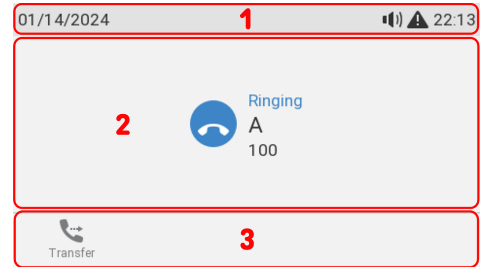
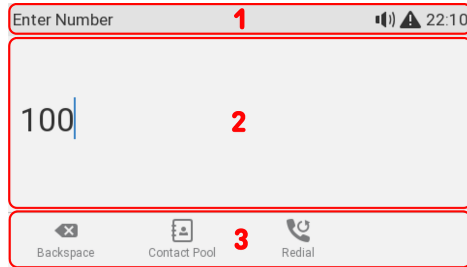

(1) Info bar/status line

- *In idle mode:* when there are active status messages → Status messages and when there are no active status messages → Date and time
- *When the phone is active:* Name of current activity

(2) Context area

- *In idle mode:* Configured identities and their actual state



Registering



Registered (active)



Not registered



Outgoing



Silent Mode



Do Not Disturb



Forwarding

- *When the phone is active:* Depending on the activity, this area will contain symbols (incoming call ringing, outgoing call ringing, list entries, etc.) and text like the phone number calling, the extension number being called, conference partners, etc. Depending on the context, the SmartLabels will or not be shown.



Outgoing ringing



Incoming ringing



Call waiting



Connected



Held by other party



Busy



Holding



Disconnected

(3) Function key line, context-sensitive

Depending on the current activity of the phone, the function key line will present various functions that can be activated by pressing the function key underneath the respective symbol. (see → *Context-sensitive, programmable function symbols and function keys*)

SmartDisplay (see → *Getting started* → *Getting to know the D785 / D785N / D787 components* → 5.2)

The phone has a second screen (SmartDisplay) where the SmartLabels of the 24 freely programmable function keys (SmartLabel keys) are displayed on 4 pages in 6 label areas each. The black horizontal bar at the top of the screen indicates which page is on-screen at the moment.

Depending on the key type, label areas are composed of icon and text, or only text respectively. Both can also be customised. The following **key types** are available with current firmware 10.1.184.14 (Release):

Default setting:

Page 1	Page 2	Page 3	Page 4
Line	Line	Line	Line
Line	Line	Line	Line
Conference	Line	Line	Line
SmartTransfer	Line	Line	Line
Silent Mode	Line	Line	Line
Dialed	Line	Line	Line

- Unknown
- Action URL
- Auto Answer
- BLF
- Button
- Call Center Status
- Call Forward
- Cancel
- Conference
- Contact (XMPP)
- Disposition Code
- DTMF
- Extension
- Intercom
- IVR
- Key Event
- ✓ Line
- Multicast
- OK
- Park
- Presence
- Push-to-Talk
- Record
- SendSipInfo
- SmartTransfer
- Speed Dial
- Star Code
- Transfer
- UserInputAndSendSipInfo
- XML Definition
- None

Key types: Line, Send SIP INFO, Star Code, Key event

Action URL	Auto Answer	Busy Lamp Field	PBX Button	Call Center Status	Call Forward
Cancel	Conference	Contact Presence (XMPP)	Disposition Code	DTMF	Extension
Intercom	IVR	Multicast	OK	Park	Presence
Push-to-Talk	Record	SmartTransfer	Speed Dial	Transfer	XML Definition

Key event:

- Unknown
- Accepted Calls
- Alternate
- Block Caller
- Call History
- ✓ Conference
- Consult Conference
- Contacts
- Delete Message
- Directory
- DND
- Executive-Assistant Behalf Of
- Executive-Assistant Config
- Favorites
- Headset
- Help
- Hide Outgoing ID
- Hold
- Hoteling
- Info
- Instant Redial
- LDAP Directory
- Logoff All
- Missed Calls
- Monitor Calls
- Multicast Zones
- Mute
- Next Identity
- Next Page
- OCI-P Directory
- Pool
- Presence
- Previous Identity
- Previous Page
- Private Hold
- Reboot
- Record
- Redial
- Server Directory
- Settings
- Silent Mode
- Voicemail
- Voicemail Info
- None

Accepted Calls	Alternate	Block caller	Call History	Conference	Consult Conference
Contacts	Delete Message	Directory	Do Not Disturb	Executive-Assistant Behalf Of	Executive-Assistant Config
Favorites	Headset	Help	Anonymous ID	Hold	Hoteling
Info	Instant Redial	LDAP Directory	Logoff All	Missed Calls	Monitor Calls

Multicast Zones	Mute	Next Identity	Next page	OCI-P Directory	Contact Pool	Presence	Previous Identity	Previous Page
Private Hold	Record	Reboot	Redial	Server Directory	Settings	Silent Mode	Voicemail	Voicemail Info

Call indicator (see → [Getting started](#) → [Getting to know the D785 / D785N / D787 components](#) → 6)

The bright-red LED situated on the top right corner of the phone indicates **incoming, ongoing, held, and missed calls**. LED status indications:

- Blinking rapidly when a call is coming in.
- Glowing steadily when dialing, when in a call, and when you have missed a call. To turn the LED off after a missed call, press the right arrow on the navigation key to view the **Missed calls** menu and simultaneously turn off the LED.
- Blinking slowly when you have put a call on hold.

SmartLabel keys (see → [Getting started](#) → [Getting to know the D785 / D785N / D787 components](#) → 7)

6 SmartLabel keys (freely programmable function keys with LEDs) on the right side of the SmartDisplay execute the functions defined by the SmartLabel. They can be programmed and labeled on the phone via menu-driven phone user interface (PUI) and on the **Function Keys** page of the phone's web user interface (WUI).

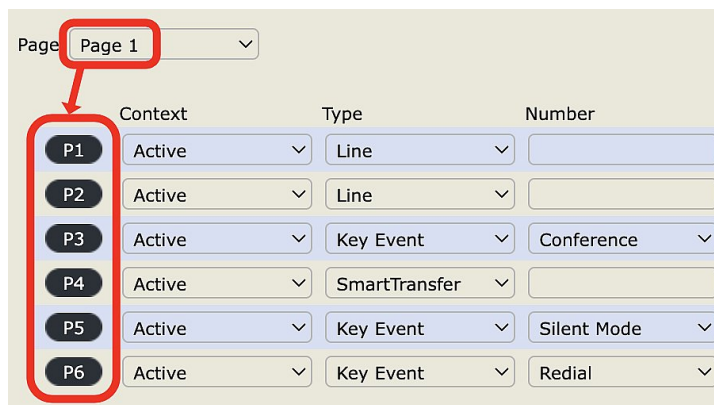

Page	Context	Type	Number
P1	Active	Line	
P2	Active	Line	
P3	Active	Key Event	Conference
P4	Active	SmartTransfer	
P5	Active	Key Event	Silent Mode
P6	Active	Key Event	Redial

Each of the **6** physical keys can be assigned to different functions on **4 SmartLabel pages**, which finally gives a total number of **24** SmartLabel keys.

You can switch between the SmartLabel pages using the following key:



SmartLabel
page

Default setting:

- Page 1: **P1-P2** → Line, **P3** → Key event: Conference, **P4** → SmartTransfer, **P5** → Key event: Silent Mode, **P6** → Key event: Dialed (Redial) → List dialed calls
- Page 2: **P7-P12** → Line
- Page 3: **P13-P18** → Line
- Page 4: **P19-P24** → Line

Depending on the function mapped onto the key, the red or green LEDs on the key will be activated when the key event occurs. The LED of a **line** key will

- blink rapidly when a call is ringing on the line
- glow steadily when there is an ongoing call on the line
- blink slowly when a call is on hold on the line
- be off when the line is free.

When other functions are mapped onto the keys, the LEDs may glow or blink. For example: When the **extension** function has been mapped onto a key and monitoring of extensions is enabled on both phones, the LED will

- blink rapidly when a call is ringing on the extension
- glow steadily when the extension is busy
- be off when the extension is not busy

Context-sensitive, programmable function symbols and function keys (see → Getting started → Getting to know the D785 / D785N / D787 components → 8)

4 context-sensitive, programmable function keys (F1 - F4) are located directly below the display and can be programmed on the **Function Keys** page of the phone's web interface (**WUI**) with a number of key events; these functions will then be available when the phone is in idle mode.

Type	Number	Label	
Key Event	Directory		F1
Key Event	Call History		F2
Call Forward			F3
Key Event	Help		F4

Default setting:

Standard functions available on idle screen. Default settings depend on the firmware installed on the phone.



Directory

F1 Internal phone directory



Call history

F2 Call lists (missed, received, dialled calls)



Forward all

F3 Forwarding all calls (on/off)



Status messages

F4 Status information or IP address



Help

Press the function key underneath the display symbol to activate the function, open the list etc. depicted by the symbol above the key.

Alphanumeric keypad (see → Getting started → Getting to know the D785 / D785N / D787 components → 9)

1 alphanumeric keypad consisting of 12 hard keys, located in the center of the lower device part.



Star key

- **In editing mode:** Press for one second to change input mode (numerals > lower case > upper case) or press briefly to type *.
- **On idle screen:** Press for 3 seconds to lock/unlock the keypad.

Audio control keys (see → [Getting started](#) → [Getting to know the D785 / D785N / D787 components](#) → 10)

5 audio control keys are used to adjust the volume, for muting and unmuting the microphone, to activate speakerphone and headset mode.

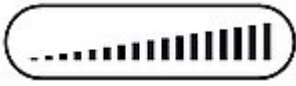

Volume + / -

- Adjusting the volume of the ringer when the phone is idle or ringing
- Adjusting the volume of the loudspeaker in handset, casing, or headset, respectively, when in call



Mute

- Muting and unmuting the microphone
- Has a **red LED** that lights up when and as long as the microphone is muted.



Speakerphone

- Toggling between handsfree and handset mode
- Dialling and accepting calls on speakerphone
- Has a **green LED** that lights up when and as long as the mode is activated



Headset

- Toggling headset mode on and off

Dedicated, customizable function keys (see → [Getting started](#) → [Getting to know the D785 / D785N / D787 components](#) → 11)

6 preprogrammed, variably programmable function keys have their factory settings printed on the key. Other functionalities can also be programmed onto them.



Message

- Retrieving messages from the mailbox (if applicable)
- Has a **red LED** that lights up when there is a new message on the mailbox



Directory

- Accessing the built-in directory of the phone



Hold

- Holding/unholding an active call



DND

- Toggling **do not disturb (DND)** mode for all identities registered on the phone



Settings

- Invoking the settings menu of the phone user interface (PUI)



Transfer

- **Transferring calls**

Navigation, confirmation, and cancel keys (see → [Getting started](#) → [Getting to know the D785 / D785N / D787 components](#) → 12)

They can be programmed with the key events available in their drop-down menus. You can select a different key event to be available on each respective key when the phone is in idle mode. You cannot change the functions that are available when the phone is active, for example when you are in a call, when the phone is ringing, etc.

Default setting:

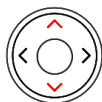

Navigation key: up/down

- **On idle screen:** Select the outgoing identity
- In other contexts: Navigate up/down

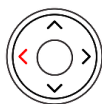

Navigation key: left

- **On idle screen:** Opening list of received calls
- **In editing mode:** Moving the cursor to the left one character at a time

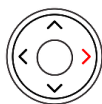

Navigation key: right

- **On idle screen:** Opening the list of missed calls and simultaneously turning off the missed call LED
- **In editing mode:** Moving the cursor to the right one character at a time



Navigation key:
center



Ok

- **On idle screen:** List dialled calls
- Accepting calls on speakerphone and in headset mode
- Confirming, saving actions & input, and returning to previous screen



Cancel

- Terminating calls on speakerphone and in headset & handset modes
- Canceling actions & input, and returning to previous screen

Putting the D785 / D785N / D787 into operation

(1) Initializing and registering the phone

Note: You will need the **registration information** received from your Internet service provider or your network administrator - normally the **phone or extension number**, the **password**, and the **registrar (SIP domain)**.

Normally the initialization is completely automatic, using DHCP. If the phone cannot discover a DHCP server in the subnet, you will be asked: **Are you using DHCP?** If your network does not support DHCP, press the **Cancel key** and enter the **IP address, netmask, IP gateway, and DNS server** manually.

Watch the display and, when prompted, **select** an option by **pressing the up or down arrow on the navigation key**. **Save** your selection by **pressing the OK key**.

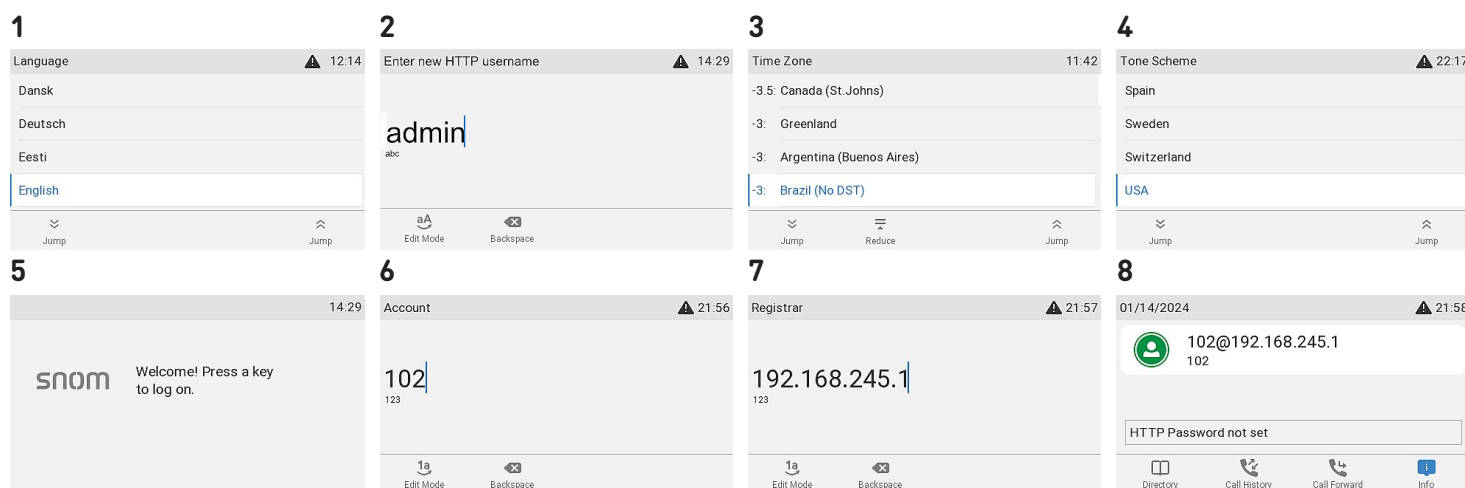

1. **Languages:** You will be prompted to select a **language**. The default is **English**.
2. Next, you will be prompted to enter a **HTTP username and password** for accessing the phone's web user interface in 2 steps. (1) The default user name (*admin*) can be used or a new one can be entered. (2) The password must be at least **six alphanumeric characters**. **Note:** You are obliged to set a proper **HTTP password** to operate the phone.
3. Time zone: Next, you will be prompted in the language of your choice to select a **time zone**. This affects the time shown on your display.
4. Tone scheme: Next, you will be prompted to select the **tone scheme** of a country. This affects the **dial tone** you hear when you pick up the receiver. Different countries use different dial tones.
5. The display shows the **Welcome** screen. Press any key to log on. **Note:** To view the phone's **IP address** at this stage, press **Settings** key.
6. Enter the **account number** and save with OK key.
7. Enter the **registrar** and save with OK key. If required, enter the **password** received from your Internet service provider or administrator. Press **OK key** to save.
8. After successful registration you will see the **idle screen**.

(2) Adjusting phone settings

A comparatively small number of settings can be adjusted directly **on the phone** via *menu-driven phone user interface (PUI)*; many more can be conveniently customized via the *phone's web user interface (WUI)* from a **computer with web browser**.

Note: Snom phones can be operated in administrator or user mode. In administrator mode, all settings are accessible and can be modified; in user mode, a number of settings are not accessible. → **Default setting:** administrator mode

If your phone is administered centrally, **user mode** may be the rule. Please check with your network administrator or VoIP provider. When the phone is running in user mode, the administrator password is required to switch to administrator mode.

Phone user interface (PUI)

Press



Settings

to open the settings menu on the display. To open submenus and settings, select the submenu or setting with the navigation key and press



Ok

Web user interface (WUI)

1. Look up the phone's **IP address**. Press



Settings

- Information
- Help

2. Enter the *IP address* into the browser's address bar on a computer in the same network as the phone.
3. The web user interface (WUI) will be invoked. If this is the first time upon manual initialization, the *Security* page is shown, otherwise the *Home screen* opens.

Note: You are obliged to set a proper **HTTP password** to operate the phone.

Available items in the vertical menu on the left side of the window depend on whether the phone is running in user or administrator mode. Any changes you make on the web interface will not take effect until you click on **Save** or on **Apply** and **Save**, depending on your firmware version. Changes will be lost if you open another page of the web interface without first clicking on **Apply/Save**.

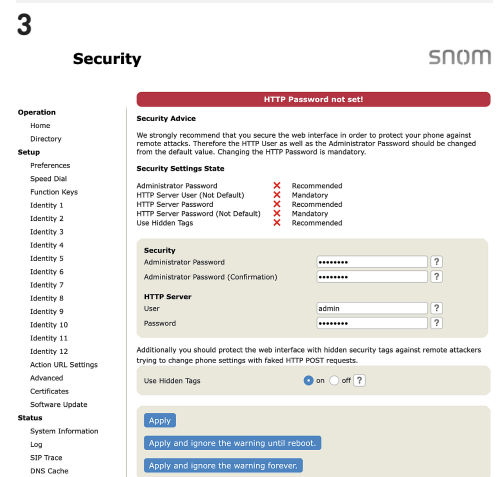
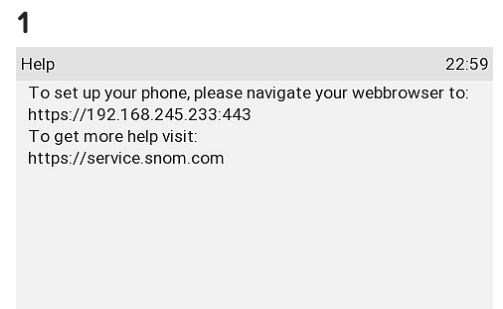

Using the phone

This section describes the functions of the phone with the factory default settings. If your phone was installed and/or set up by someone else, the default settings may have been changed. Please check with that person or company if the phone does not react as described here.

The caller information displayed on the screen is controlled by a setting on the phone's web interface. The default setting is *Name + Number*. You can change the setting at *Preferences > General Information > Number Display Style* by selecting a different option from the drop-down list.

(1) Making calls

1. **Selecting identity** for current outgoing call

2. Using different **audio devices**

- Handset:

Pick up the handset, enter the phone number, and confirm with **Ok** or enter the phone number and pick up the handset.



Ok

or

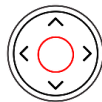

Navigation key: center

- Headset:

Enter the phone number and press



Headset

- Speakerphone:

Enter the phone number and press



Speakerphone

(2) Accepting calls

Using different **audio devices**

- Handset: Pick up the handset.
- Headset: Press



Headset

- Speakerphone: Press

or



Speakerphone



Ok

or

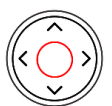

Navigation key: center

If the phone is already in headset mode, you can also press the blinking line key.

(3) Terminating calls

- When using the handset: place the handset in the cradle or
- When using speakerphone or a headset:

Press



Cancel

(4) Active calls**One call on hold**

Press



Hold

or press the function key underneath the following symbol



Hold

to put the ongoing call on hold. Held calls are indicated as follows:

- By the text on the display.
- By the slowly blinking line key.
- By the slowly blinking call indication LED.
- By the double beep when you put a call on hold.

You can now:

- transfer the held call blindly or with prior announcement.
- receive and make calls and put other calls on hold.

Pick up the held call by pressing its line key or press again



Hold

or press the function key underneath the following symbol



Retrieve

If the other party hangs up while on hold, the call is terminated on your phone as well and the LED indicators are turned off.

Holding multiple calls

If you are in a call with one party and have one or more calls on hold or if there is more than one call on hold, the following symbols are shown in the function key line according to the use case.



Back to active call



Previous held call



Next held call

You can now:

- switch back and forth between the active call and any call on hold. Up to 12 simultaneous calls are possible, if supported by the VoIP telephony system.
- When the connected call is on-screen, you can transfer it to a third party or terminate it.
- When a held call is on-screen, press



Ok

to connect to it and put the currently connected call on hold.

(5) Conference

The maximum number of participants in phone-based conferences is **3** (you and 2 others). For the number of participants in server-based conferences and how to set up and join them, please check with your network administrator or your VoIP provider.

- 1. Initiating a conference:** Call the first intended participant (**B, 101**) and put the connected call on hold.

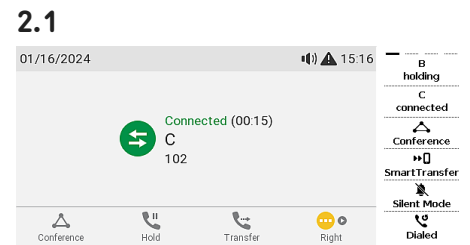
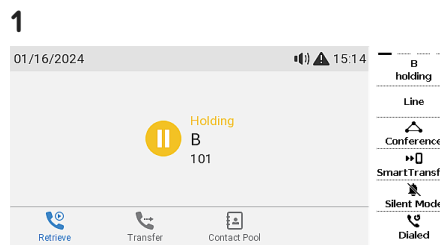

- Call the next intended participant (**C, 102**) and announce the conference. Put the connected call (**C, 102**) on hold.

- Press the function key underneath the following symbol

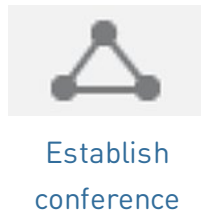

to start the 3-way conference

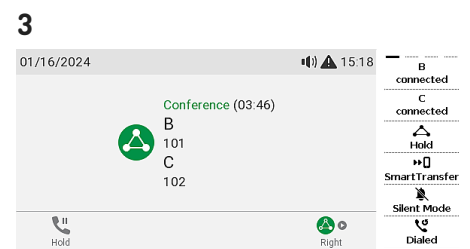
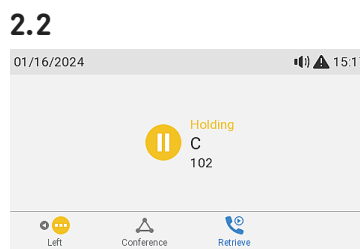

You can now:

- Select individual participants by pressing the corresponding function key below one of these icons
- Talk to one of the participants in private. With one of the participants on-screen, press
- Put one participant on hold. With one of the participants on-screen, press
- Terminate the conference and the connections to both parties by returning to the conference screen.



Previous participant

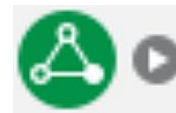

Next participant



Back to conference



Ok

To restart the conference, press the function key below



Establish conference



Hold

To restart the conference, press the function key below



Establish conference



Back to conference

→ Press



Cancel

(5) Transferring calls

You can transfer connected calls as well as deflect calls ringing on your phone.

- When you have a call on the line, there are two ways to transfer it to a third party
 1. **Attended call transfer:** Announcing the call to the third party first, to make sure the call is welcome and will be accepted.
 2. **Blind call transfer:** There will be no feedback on whether the third party is available and/or picking up the call.
- When a call is ringing on your phone, you can redirect it to a third party without answering it first. → [Call deflection](#)

Attended call transfer: with a single call on the phone

1. Put the connected call (**B, 101**) on hold.

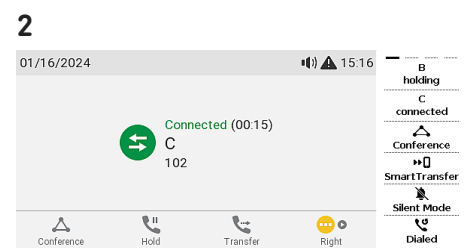
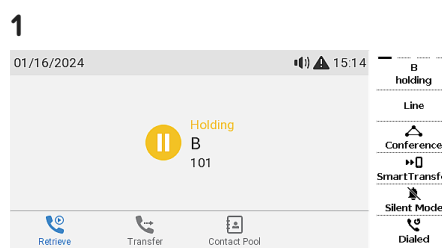

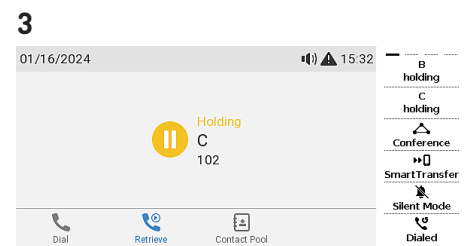
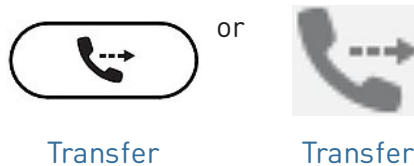

2. Dial the number (**C, 102**) you want to transfer the call (**B, 101**) to and announce the call.

3. If the third party (**C, 102**) wants to accept the call, press



→ The call (**C, 102**) is put on hold.

4. Press  or 
 Ok Navigation key: center

to complete the transfer.

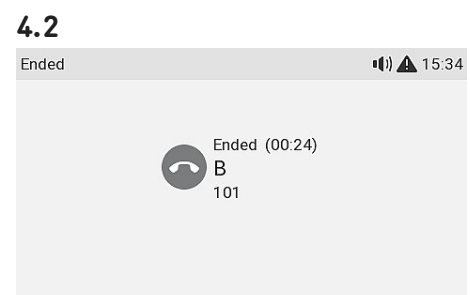
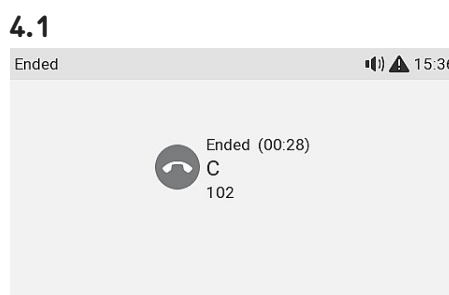

→ You may briefly see screen messages *Ended C 102* and *Ended B 101* indicating that the transfer was completed. **B (101)** is in a call with **C (102)** now.

Attended call transfer: with more than one call

1. Dial the number **(C, 102)** you want to transfer the call **(B, 101)** to and announce the call.

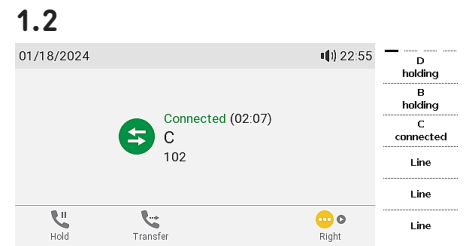
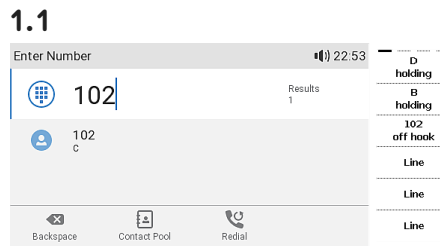

2. If the third party **(C, 102)** wants to accept the call, press



Transfer

or press the function key underneath the following symbol



Transfer

→ The call **(C, 102)** is put on hold.

Note: If the *Holding D 103* screen, i.e., the call you do not want to transfer, appears on-screen, select the other held call **B 101** to bring *Holding B 101* on-screen.

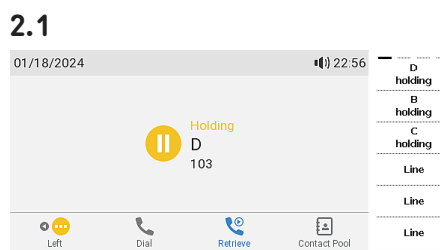

Previous held call

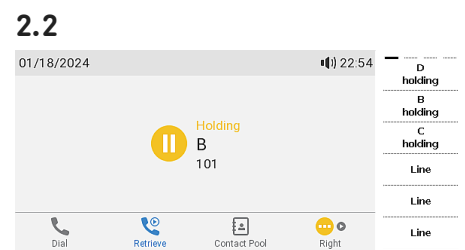

Next held call

3. Press



Ok

or

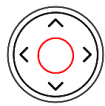

Navigation key: center

to complete the transfer.

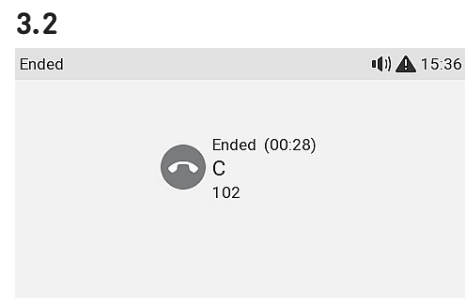
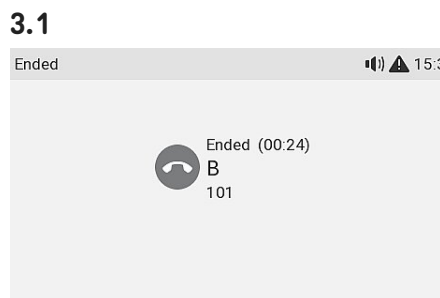

→ You may briefly see screen messages *Ended B 101* and *Ended C 102* indicating that the transfer was completed. **B (101)** is in a call with **C (102)** now.

→ The remaining call on hold or the first of the remaining calls on hold will then appear on-screen **(D, 103)**.

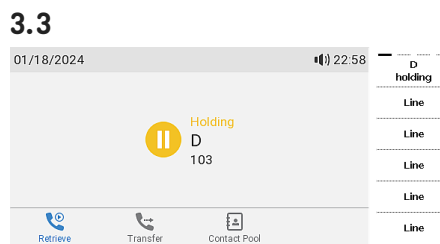

Blind call transfer: active call

1. With an active call (**B, 101**) on the line, press

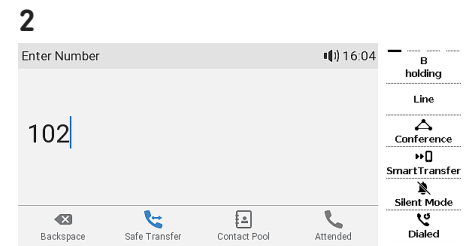
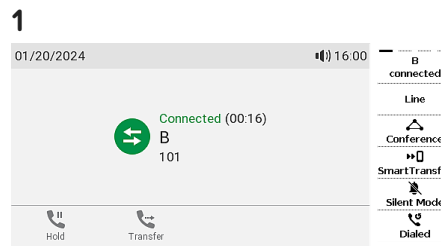
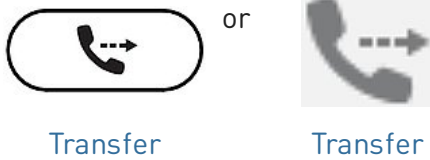

→ The call (**B, 101**) is put on hold. The **dial screen** will appear.

2. Dial the number (**C, 102**) you want to transfer the call to blindly (unannounced), or select one from one of the available phone directories.

3. Press



Ok

Navigation key:
center

to complete the transfer. → You may briefly see screen message *Ended B 101* indicating that the transfer was completed. **B (101)** is ringing **C (102)** now.

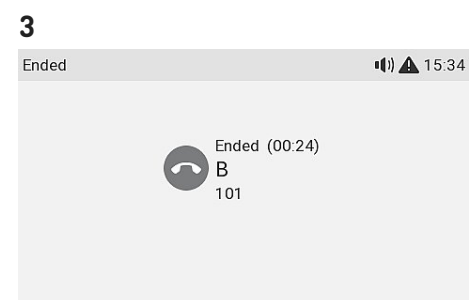

Call deflection (active call **B 101** and call waiting **C 102**)

1. If you are in an active call (**B, 101**) and want to transfer an incoming call waiting (**C, 102**), press the function key underneath



Next call waiting

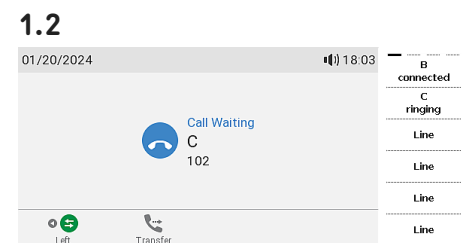
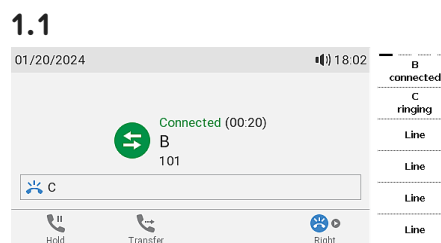

→ The incoming call waiting appears on-screen. Your active call remains active while you are transferring the ringing call.

2. Press



→ The **dial screen** will appear.

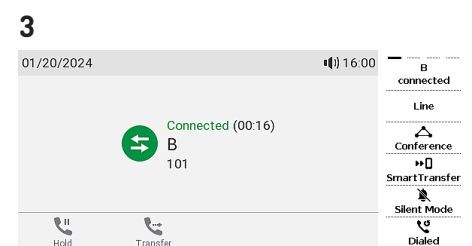
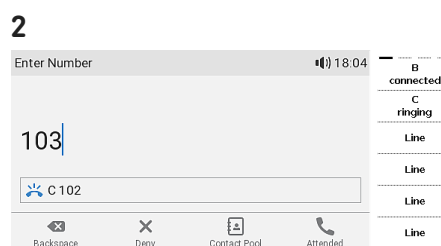

3. Dial the number (**D, 103**) you want to transfer the call to blindly (unannounced), or select one from one of the available phone directories. → **C (102)** is ringing **D (103)** now. Your active call (**B, 101**) reappears on-screen.

Call deflection (ringing call **B 101**)

1. With an incoming call ringing (**B, 101**), press

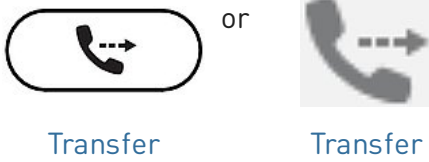

→ The **dial screen** will appear.

2. Dial the number (**C, 102**) you want to transfer the call to blindly (unannounced), or select one from one of the available phone directories.

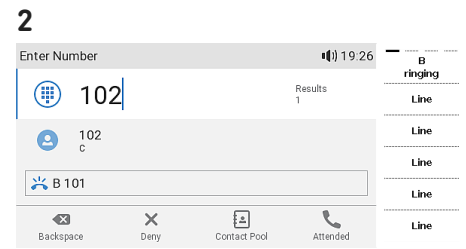
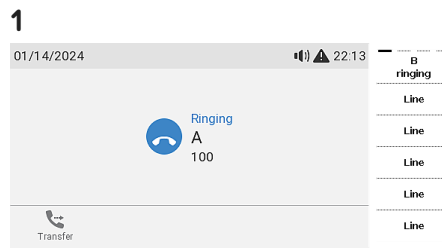

3. Press

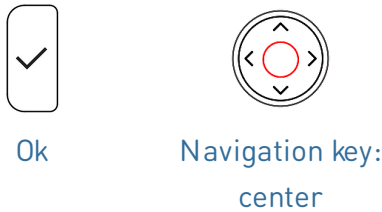

to complete the transfer. → **B (101)** is ringing **C (102)** now.

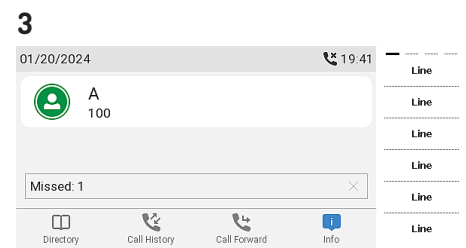

(6) Call lists

Three call lists of **missed, dialed, and received** calls are stored on the phone. They contain the **number, time and date, and duration** of the calls. If the memory allotted to storing the call lists is full, the **oldest ones will be overwritten**.

1. **On idle screen:** press the function key underneath the following symbol



Call history

2. To display the lists of missed, received, or dialed calls on-screen, use the navigation key (left/right). On each list, the latest call is at the top of the list. Scroll through the list using the navigation key (up/down). The icons indicate the type of call.

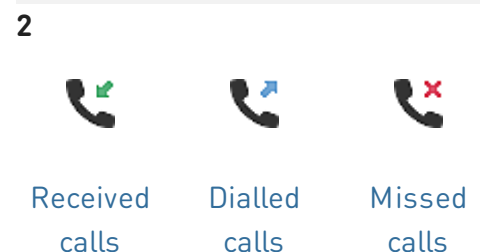
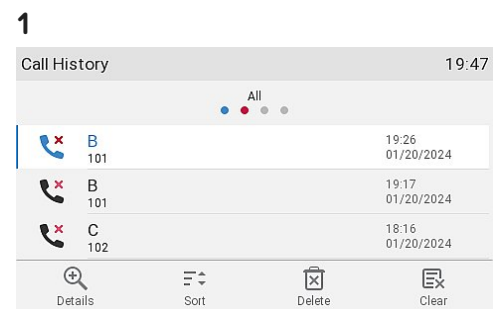

Note: The red dot indicates the arrival of new missed messages since the last time the missed calls were viewed. It is removed from the list of all calls and turns blue in the list of missed calls once the list has been viewed.

Software update

Manual update

1. Go to Snom's Firmware Update Center and find the latest firmware version for your phone.
2. Please read the instructions and release notes before downloading the firmware.
3. **Right-click** the *download link* in the Firmware files table and **copy the link**.

Downloads

Firmware Files

Phone Model	File Size	SHA-256 Checksum	Download Link
D785	41.0 MB	1ddc1588dd0a4cabdc9f0bb89d7de2bf1443566f458a3fb03a76b69b42fd1556	https://downloads.snom.com/fw/10.1.184.14/bin/snomD785-10.1.184.14-HW1-SIP-r.bin#

4. Open the phone's web user interface (WUI) and navigate to *Software Update* page. In the *Manual Software Update* area, paste the link into the text field of **Firmware**.

Manual Software Update

SNOM

HTTP Password not set!

You may explicitly specify which software version you want to run on this phone. Fill in the http URL which is pointing to the firmware you want to use. Please use only a complete http URL (like <http://www.example.com/firmware.bin>). The phone will reboot after you press the load button.

Manual Software Update

Firmware ?

Load

Your phone is shipped with a valid license preinstalled. It is possible to install a new license file via the manual license upload to enable additional software features or to reinstall the preinstalled license in case it is missing or damaged. If the uploaded license file is invalid (e.g. not matching the MAC address of the phone) it will be ignored and the existing license is kept.

Manual License Upload

License file Choose File

Load

Software Update

5. Click **Load**. The phone begins to reboot. If the phone challenges a *Reboot?* message, please confirm.

Note: DO NOT DISCONNECT THE POWER WHILE THE PHONE IS REBOOTING!

Auto provisioning

1. Open the phone's web user interface (WUI) and navigate to the *Advanced Settings* page > *Update* tab.
2. Please click on the help symbol of each line and read the information on each setting carefully before you configure the setting.
3. When done, click **Apply**. If you have the changed the setting URL and/or the *PnP configuration*, a reboot is required before they will take effect.

For more information, see our [web page](#).

Troubleshooting

Contacting Snom Support

Click [this text](#) to read and follow the detailed instructions given on our website.

Submitting a ticket

Click [this text](#) to read and follow the detailed instructions given on our website.

Submitting system and settings information

- [System information](#)
- [Settings information](#)

SIP traces

Snom Support may ask you to submit a SIP Trace and/or a PCAP Trace to help them analyze your problem.

- [Performing a SIP trace](#)
- [Performing a PCAP trace](#)

Important information

This **Short User Manual for D785 / D785N / D787** has been derived from the more extensive user manual to give users a more concise overview in their own language. Please refer to the **D785 / D785N / D787 user manual** regarding the following topics:

- [Copyright, Trademarks, GPL, Legal Disclaimers](#)
- [Safety instructions](#)
- [Standards conformance](#)
- [Product specifications](#)
- [Disposal of the device](#)
- [Cleaning](#)

Disclaimer

Further information: [Snom D785 / D785N / D787 webpage](#) | [Snom Service Hub](#) | [Data sheet](#) | [User manual](#) | [Warranty information](#) | [Type approval](#) | [Company locations](#)

Snom, the names of Snom products, and Snom logos are trademarks owned by Snom Technology GmbH. All product specifications are subject to change without notification. Snom Technology GmbH reserves the right to revise and change this document at any time, without being obliged to announce such revisions or changes beforehand or after the fact. Although due care has been taken in the compilation and presentation of the information in this document, the data upon which it is based may have changed in the meantime. Snom therefore disclaims all warranties and liability for the accurateness, completeness, and currentness of the information published, except in the case of intention or gross negligence on the part of Snom or where liability arises due to binding legal provisions.